



## QUEST-X GX1500S

25 Watt VHF/FM

ITU Class D DSC Marine Transceiver

---

### Owner's Manual

- Waterproof construction
- Commercial grade ITU Class D DSC VHF
- Independent Channel 70 receiver built-in for continuous DSC watching
- Capable of connecting up to one second station microphone
- Intercom between radio and second station microphone
- DSC position request and send functions with compatible STANDARD HORIZON GPS Chart plotters
- Versatile user-programmable scanning, priority scan and Dual Watch
- One-button access to Channel 16 and 9
- Oversized rotary channel knob, backlit display and keys.
- Navigation information shown on display when optional GPS connected

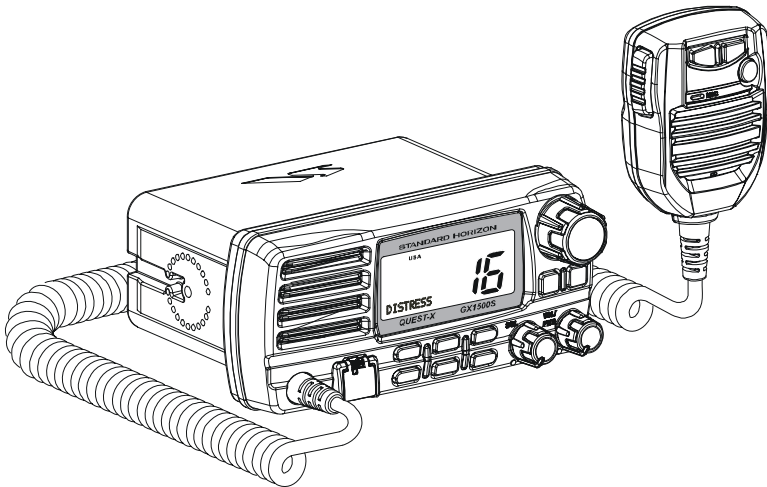

# TABLE OF CONTENTS

<b>1</b>	<b>GENERAL INFORMATION</b>	<b>4</b>
<b>2</b>	<b>PACKING LIST</b>	<b>4</b>
<b>3</b>	<b>OPTIONS</b>	<b>4</b>
<b>4</b>	<b>SAFETY / WARNING INFORMATION</b>	<b>5</b>
<b>5</b>	<b>FCC RADIO LICENSE INFORMATION</b>	<b>6</b>
<b>6</b>	<b>FCC NOTICE</b>	<b>7</b>
<b>7</b>	<b>GETTING STARTED</b>	<b>8</b>
	7.1 ABOUT VHF RADIO	8
	7.2 SELECTING AN ANTENNA	8
	7.3 COAXIAL CABLE	9
<b>8</b>	<b>INSTALLATION</b>	<b>10</b>
	8.1 LOCATION	10
	8.2 ELECTRICAL CONNECTIONS	10
	8.3 ACCESSORY CABLE	11
	8.4 CONNECTION OF GPS WITH NMEA OUTPUT	12
	8.5 CHECKING GPS CONNECTIONS	12
	8.6 CHANGING THE GPS TIME	13
	8.7 CHANGING THE TIME LOCATION	14
	8.8 CHANGING COG TO TRUE OR MAGNETIC	14
	8.9 OPTIONAL MMB-84 FLUSH MOUNT INSTALLATION	15
	8.10 OPTIONAL ENHANCED RAM+ SECOND STATION MIC AND/OR VH-310 HANDSET INSTALLATION	16
<b>9</b>	<b>CONTROLS AND INDICATORS</b>	<b>18</b>
<b>10</b>	<b>BASIC OPERATION</b>	<b>24</b>
	10.1 RECEPTION	24
	10.2 TRANSMISSION	24
	10.3 TRANSMIT TIME-OUT TIMER (TOT)	24
	10.4 SIMPLEX / DUPLEX CHANNEL USE	25
	10.5 USA, CANADA, AND INTERNATIONAL MODE	25
	10.6 NOAA WEATHER CHANNELS	25
	10.6.1 NOAA Weather Alert	25
	10.6.2 NOAA Weather Alert Testing	26
	10.7 EMERGENCY (CHANNEL 16 USE)	26
	10.8 CALLING ANOTHER VESSEL (CHANNEL 16 OR 9)	27
	10.9 MAKING TELEPHONE CALLS	27
	10.10 OPERATING ON CHANNELS 13 AND 67	28
	10.11 DUAL WATCH (TO PRIORITY CHANNEL)	28
	10.12 SCANNING	29
	10.12.1 Selecting the Scan Mode	29
	10.12.2 Memory Scanning (M-SCAN)	29
	10.12.3 Priority Scanning (P-SCAN)	30
	10.13 NAVIGATION INDICATION	30
	10.14 INTERCOM OPERATION	31
	10.14.1 Communication	31
	10.14.2 Calling	31
<b>11</b>	<b>DIGITAL SELECTIVE CALLING</b>	<b>32</b>
	11.1 GENERAL	32
	11.2 MARITIME MOBILE SERVICE IDENTITY (MMSI)	32
	11.2.1 What is an MMSI?	32
	11.2.2 Programming the MMSI	33
	11.3 DSC DISTRESS CALL	34
	11.3.1 Transmitting a DSC Distress Call	34
	11.3.2 Receiving a DSC Distress Call	36
	11.4 ALL SHIPS CALL	36
	11.4.1 Transmitting an All Ships Call	37
	11.4.2 Receiving an All Ships Call	37

# TABLE OF CONTENTS

11.5	INDIVIDUAL CALL .....	38
11.5.1	Setting up the Individual / Position Call Directory .....	38
11.5.2	Setting up Individual Ringer .....	39
11.5.3	Setting up Individual / Group Call Ringer .....	40
11.5.4	Transmitting an Individual Call .....	41
11.5.5	Receiving an Individual Call .....	43
11.5.6	Call Waiting Directory .....	43
11.6	GROUP CALL .....	45
11.6.1	Setting up a Group Call .....	45
11.6.2	Transmitting a Group Call .....	46
11.6.3	Receiving a Group Call .....	48
11.7	POSITION REQUEST .....	49
11.7.1	Setting up Position Reply .....	49
11.7.2	Transmitting a Position Request to Another Vessel .....	50
11.7.3	Receiving a Position Request .....	52
11.8	POSITION SEND .....	53
11.8.1	Setting up Position Send Ringer .....	53
11.8.2	Transmitting a DSC Position Send Call .....	54
11.8.3	Receiving a DSC Position Send Call .....	55
11.9	MANUAL INPUTTING OF THE GPS LOCATION (LAT/LON) .....	56
<b>12</b>	<b>RADIO SETUP MODE .....</b>	<b>58</b>
12.1	LAMP ADJUSTING .....	58
12.2	LCD CONTRAST .....	58
12.3	TIME OFFSET .....	59
12.4	TIME LOCATION .....	60
12.5	TRUE MAGNETIC CHANGE (NAV display) .....	60
12.6	PRIORITY CHANNEL SET .....	61
12.7	SCAN TYPE .....	61
12.8	SCAN RESUME TIME .....	62
12.9	KEY BEEP (ON/OFF) .....	62
12.10	WX ALERT .....	63
12.11	CHANNEL NAME CHANGE .....	64
12.12	NAMING THE RADIO OR RAM+ STATIONS .....	65
<b>13</b>	<b>ENHANCED RAM+ MIC OPERATION .....</b>	<b>66</b>
13.1	RAM+ MIC CONTROLS .....	66
13.2	INTERCOM OPERATION .....	69
13.2.1	Communication .....	69
13.2.2	Calling .....	69
13.3	DSC / RADIO SETUP MODE .....	70
<b>14</b>	<b>VH-310 HANDSET OPERATION .....</b>	<b>72</b>
14.1	VH-310 HANDSET CONTROLS .....	72
14.2	INTERCOM OPERATION .....	76
14.2.1	Communication .....	76
14.2.2	Calling .....	76
14.3	MANUAL INPUTTING OF THE GPS LOCATION (LAT/LON) .....	77
14.4	DSC / RADIO SETUP MODE .....	78
14.4.1	Changing GPS Information to Vessel position or COG .....	79
14.4.2	External Speaker AF Selection .....	79
<b>15</b>	<b>MAINTENANCE .....</b>	<b>80</b>
15.1	REPLACEMENT PARTS .....	80
15.2	FACTORY SERVICE .....	81
15.3	TROUBLESHOOTING CHART .....	81
<b>16</b>	<b>CHANNEL ASSIGNMENTS .....</b>	<b>82</b>
<b>17</b>	<b>WARRANTY .....</b>	<b>88</b>
<b>18</b>	<b>SPECIFICATIONS .....</b>	<b>91</b>

## 1 GENERAL INFORMATION

The Vertex Standard **GX1500S** is a VHF/FM transceiver designed for use in the frequency range of 156.025 to 163.275 MHz. The **GX1500S** can be operated from 11 to 16 VDC and has a switchable RF output power of 1 watt or 25 watts.

The **GX1500S** is capable of DSC (Digital Selective Calling) Class D operation and an Enhanced second station RAM+ mic (**CMP25** remote-control speaker/microphone with display) or **VH-310** Handset. Class D operation allows continuous receiving of Digital Selective Calling functions on channel 70 even if the radio is receiving a call.

## 2 PACKING LIST

When the package containing the transceiver is first opened, please check it for the following contents:

- **GX1500S** Transceiver
- Mounting Bracket and attaching hardware
- Panel Cover
- Owner's Manual
- Power Cord

## 3 OPTIONS

<b>MMB-84</b> .....	Flush-Mount Bracket
<b>CMP25B/W</b> .....	Remote-Access Microphone (RAM+ Mic, Black/White)
<b>VH-310</b> .....	Remote Handset (available in Black)
<b>CT-100</b> .....	23-foot Extension Cable for RAM+ Mic
<b>MLS-310</b> .....	Amplified External Speaker
<b>MLS-300</b> .....	External Loudspeaker
<b>101W</b> .....	White External Speaker

## 4 SAFETY / WARNING INFORMATION

This radio is restricted to occupational use, work related operations only where the radio operator must have the knowledge to control the exposure conditions of its passengers and bystanders by maintaining the minimum separation distance of 0.6 m (2 feet).

Failure to observe these restrictions will result in exceeding the FCC RF exposure limits.

### **Antenna Installation:**

The antenna must be located at least 0.6 m (2 feet) away from passengers in order to comply with the FCC RF exposure requirements.

## ON-LINE WARRANTY REGISTRATION

Please visit [www.standardhorizon.com](http://www.standardhorizon.com) to register the **GX1500S** Marine VHF. It should be noted that visiting the Web site from time to time may be beneficial to you, as new products are released they will appear on the Marine Division of Vertex Standard Web site.

### **PRODUCT SUPPORT INQUIRIES**

If you have any questions or comments regarding the use of the **GX1500S**, you can visit the Marine Division of Vertex Standard Web site to send an E-Mail or contact the Product Support team at 800-767-2450 M-F 7:00-5:00PST.



## 5 FCC RADIO LICENSE INFORMATION

Vertex Standard radios comply with the Federal Communication Commission (FCC) requirements that regulate the Maritime Radio Service.

### STATION LICENSE

An FCC ship station license is no longer required for any vessel traveling in U.S. waters (except Hawaii) which is under 20 meters in length. However, any vessel required to carry a marine radio on an international voyage, carrying a HF single side band radiotelephone or marine satellite terminal is required to have a ship station license. FCC license forms, including applications for ship (506) and land station licenses can be downloaded via the Internet at [www.fcc.gov/forms](http://www.fcc.gov/forms). To obtain a form from the FCC, call (888) 225-5322.

### RADIO CALL SIGN

Currently the FCC does not require recreational boaters to have a Ship Radio Station License. The USCG recommends the boats registration number and the state to be used.

### CANADIAN SHIP STATION LICENSING

You may need a license when traveling in Canada. If you do need a license contact their nearest field office or regional office or write:

**Industry Canada  
Radio Regulatory Branch  
Attn: DOSP  
300 Slater Street  
Ottawa, Ontario  
Canada, KIA 0C8**

### FCC / INDUSTRY CANADA INFORMATION

The following data pertaining to the transceiver is necessary to fill out the license application.

Type Acceptance ..... FCC Part 80  
Output Power ..... 1 Watt (low) and 25 Watts (high)  
Emission ..... 16K0G3E, 16K0G2B  
Frequency Range ..... 156.025 to 163.275 MHz  
FCC Type Number ..... K6630173X3D  
Industry Canada Type Approval ..... 511B-30173X3D

## 6 FCC NOTICE

### NOTICE

Unauthorized changes or modifications to this equipment may void compliance with FCC Rules. Any change or modification must be approved in writing by Marine Division of Vertex Standard.

### NOTICE

This equipment has been tested and found to comply with the limits for a Class B digital device, pursuant to Part 15 of the FCC Rules. These limits are designed to provide reasonable protection against harmful interference in a residential installation. This equipment generates, uses and can radiate radio frequency energy and, if not installed and used in accordance with the instructions, may cause harmful interference to radio communications. However, there is no guarantee that interference will not occur in a particular installation. If this equipment does cause harmful interference to radio or television reception, which can be determined by turning the equipment off and on, the user is encouraged to try to correct the interference by one or more of the following measures:

- Reorient or relocate the receiving antenna.
- Increase the separation between the equipment and receiver.
- Connect the equipment into an outlet on a circuit different from that to which the receiver is connected.
- Consult the dealer or an experienced radio/TV technician for help.



## **7 GETTING STARTED**

### **7.1 ABOUT VHF RADIO**

The radio frequencies used in the VHF marine band lie between 156 and 158 MHz with some shore stations available between 161 and 163 MHz. The marine VHF band provides communications over distances that are essentially “line of sight” (VHF signals do not travel well through objects such as buildings, hills or trees). Actual transmission range depends much more on antenna type, gain and height than on the power output of the transmitter. On a fixed mount 25W radio transmission expected distances can be greater than 15 miles.

### **7.2 SELECTING AN ANTENNA**

Marine antennas are made to radiate signals equally in all horizontal directions, but not straight up. The objective of a marine antenna is to enhance the signal toward the horizon. The degree to which this is accomplished is called the antenna’s gain. It is measured in decibels (dB) and is one of the major factors in choosing an antenna. In terms of effective radiated power (ERP), antennas are rated on the basis of how much gain they have over a theoretical antenna with zero gain. A 3 foot, 3dB gain antenna represents twice as much gain over the imaginary antenna.

Typically a 3 foot 3dB gain stainless steel whip is used on a sailboat mast. The longer 8 foot 6dB fiberglass whip is primarily used on power boats that require the additional gain.



### 7.3 COAXIAL CABLE

VHF antennas are connected to the transceiver by means of a coaxial cable – a shielded transmission line. Coaxial cable is specified by its diameter and construction.

For runs less than 20 feet, RG-58/U, about 1/4 inch in diameter is a good choice. For runs over 20 feet but less than 50 feet, the larger RG-8X should be used for cable runs over 50 feet RG213 should be used. For installation of the connector onto the coaxial cable refer to the figure below.

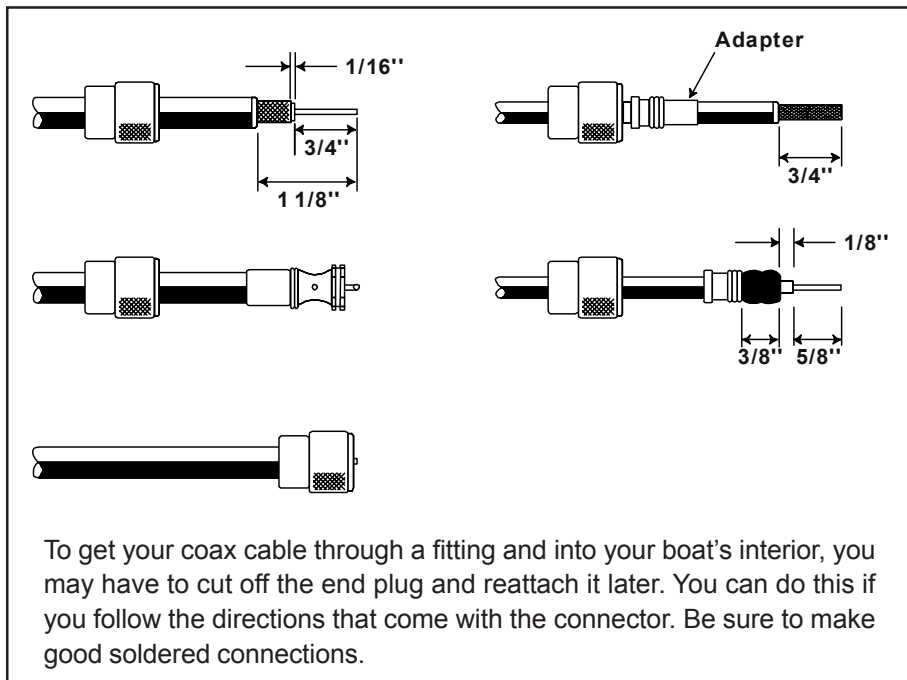

## 8 INSTALLATION

### 8.1 LOCATION

The radio can be mounted at any angle. Choose a mounting location that:

- is far enough from any compass to avoid any deviation in compass reading due to the speaker magnet
- provides accessibility to the front panel controls
- allows connection to a power source and an antenna
- has nearby space for installation of a microphone hanger
- the antenna must be mounted at least 3 feet from radio

**Note:** To insure the radio does not affect the compass or radios performance is not affected by the antenna location, temporarily connect the radio in the desired location and:

- a. Examine the compass to see if the radio causes any deviation
- b. Connect the antenna and key the radio. Check to ensure the radio is operating correctly by requesting a radio check.

### 8.2 ELECTRICAL CONNECTIONS

#### CAUTION

**Reverse polarity connections will damage the radio!**

Connect the power cord and antenna to the radio. Antenna and Power Supply connections are as follows (see Figure 1):

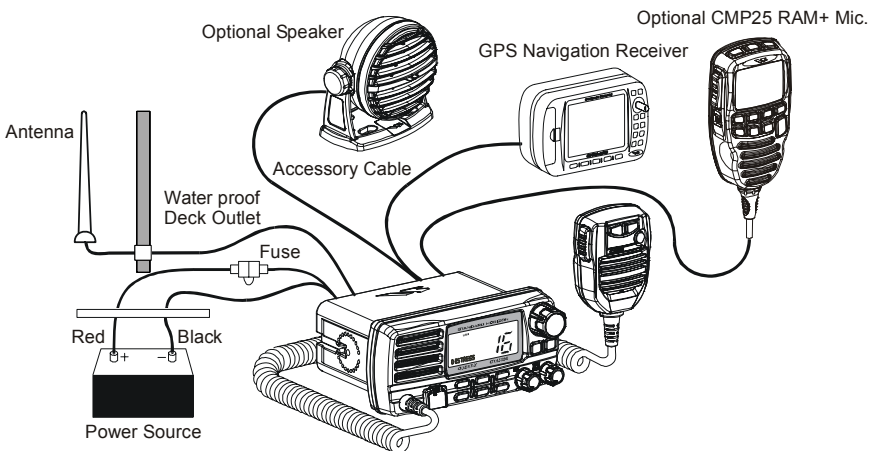

**Figure 1. General Installation**

1. Mount the antenna at least 3 feet away from the radio. At the rear of the radio, connect the antenna cable.
2. Connect the red power wire to a 13.8 VDC  $\pm 20\%$  power source. Connect the black power wire to a negative ground.

3. If an optional remote extension speaker is to be used, refer to next section for connections.
4. It is advisable to have a Certified Marine Technician check the power output and the standing wave ratio of the antenna after installation.

### Fuse Replacement

To take out the Fuse from the Fuse Holder, hold the both ends of the Fuse Holder and pull the Fuse Holder apart, do not bend the Fuse Holder. When you replace the Fuse, please confirm that the Fuse use is tightly fixed on the metal contact located inside the Fuse Holder. If the metal contact holding the fuse is loose, the Fuse holder may heat up.

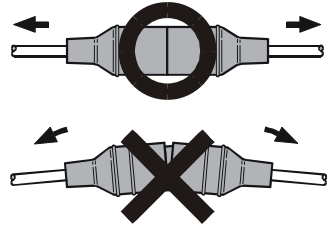

### 8.3 ACCESSORY CABLE

- External speaker (+)
- External speaker (-)
- NMEA IN (+) from GPS navigation receiver
- NMEA IN (-) from GPS navigation receiver
- NMEA OUT (+) to GPS navigation receiver

When connecting the external speaker or GPS navigation receiver, strip off about 1 inch (2.5 cm) of the specified wire's insulation, then splice the ends together using proper waterproofing techniques.

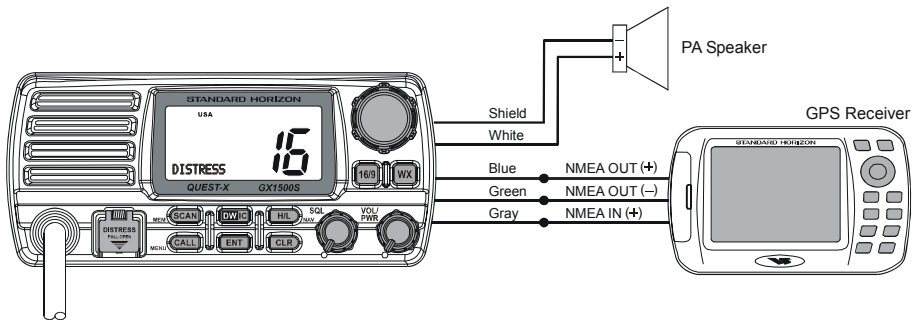

Wire Color/Description	Connection Examples
WHITE - External Speaker (+)	Connect to external 4 Ohm audio speaker
SHIELD - External Speaker (-)	Connect to external 4 Ohm audio speaker
BLUE- NMEA Input (+)	Connect to NMEA (+) output of GPS
GREEN- NMEA Input (-)	Connect to NMEA (-) output of GPS
GRAY- NMEA Output (+)	Connect to NMEA (+) input of GPS
BROWN-NMEA Output (-)	No connection

## 8.4 CONNECTION OF GPS WITH NMEA OUTPUT

Manufacturer/Model	Wires	GX3500S	Manufacturer/Model	Wires	GX3500S
STANDARD HORIZON	Green	Green	Lowrance Portable	Orange	Blue
	Blue	Gray		Black (GND)	Green
	Brown	Blue	Magellan Fixed Mount	Gray	Blue
Furuno GP30, 36	White	Blue	Black (GND)	Green	
	Blue	Green	Magellan Portable	Orange	Blue
Furuno GP1650, 1850	White	Blue	Black (GND)	Green	
	Black	Green	Northstar	Yellow	Blue
Garmin Fixed Mounts	Blue	Blue	Black (GND)	Green	
	Black (GND)	Green	Raytheon 420	Yellow	Blue
Garmin Portables	Brown	Blue	Brown	Green	
	Black (GND)	Green	Raytheon 520 / 620	Blue	Blue
JRC GPS500	Yellow	Blue	Brown	Green	
	Green	Green	Raytheon RL SERIES	White	Blue
JRC 100 SERIES	Green	Blue	Brown	Green	
	Black	Green	Simrad	White	Blue
JRC 200 SERIES	White	Blue	Brown	Green	
	Black	Green	Sitex Neptune, Nautilus	Gray	Blue
Lowrance Fixed Mount	White	Blue	Brown	Green	
	Black (GND)	Green			

- The GPS must have the NMEA Output turned on and set to 4800 Baud in the setup menu. If there is a selection for parity select none.
- For further information on interfacing /setting up your GPS. Please contact the manufacturer of the GPS receiver.
- **GX1500S** can read NMEA-0183 version 2.0 or higher.
- The NMEA supported sentences are:  
Input: GLL, GGA, RMC and GNS (RMC sentence is recommended)  
Output: DSC and DSE  
(DSC sentences to Standard Horizon Plotter for Position Polling)

If you have further inquires, please feel free to contact Product Support at:

Phone: (800) 767-2450

Email: [marinetech@vxstdusa.com](mailto:marinetech@vxstdusa.com)

## 8.5 CHECKING GPS CONNECTIONS

After connections have been made between the **GX1500S** and the GPS, a small satellite icon will appear on the top right corner of the LCD display. To see the additional GPS information, press and hold the [H/L(NAV)] key. The **GX1500S** shows the Date, Time, SOG and COG.

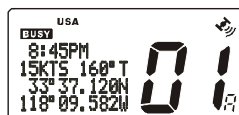

## 8.6 CHANGING THE GPS TIME

From the Factory the **GX1500S** shows GPS satellite time or UTC time. A time offset is needed to show the local time in your area.

1. Press and hold down the [CALL(MENU)] key until “Radio Setup” menu appears.
2. Press the [ENT] key, then select “Time Set” with the CHANNEL selector knob.
3. Press the [ENT] key.
4. Turn the CHANNEL selector knob to select time offset from UTC. See illustration below to find your offset time from UTC. If “0:00” is assigned, the time is the same as UTC (Universal Time Coordinated or GMT Greenwich Mean Time).
5. Press the [ENT] key to store the time offset.
6. Press the [16/9] key or turn the CHANNEL selector knob to select “Exit,” then press the [ENT] key to return to the “Radio Setup” menu, select “Exit” and press the [ENT] key to return to radio operation.

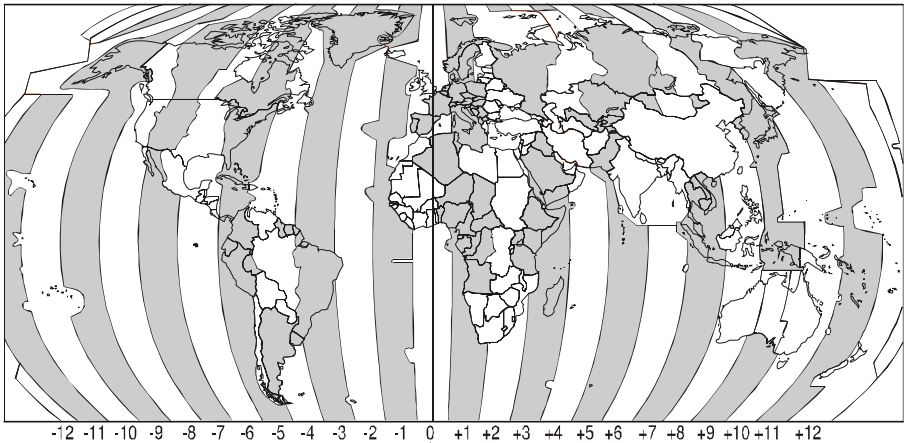
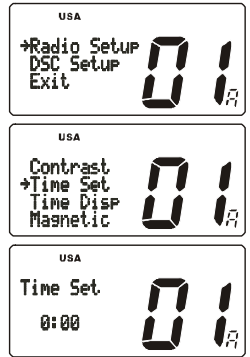

UTC/GMT  
**OFFSET TIME TABLE**

## 8.7 CHANGING THE TIME LOCATION

Sets the radio to show UTC time or local time with the offset inputted in section 8.6 Changing the GPS Time.

1. Press and hold down the [CALL(MENU)] key until “Radio Setup” menu appears.
2. Press the [ENT] key, then select “Time Disp” in the “Radio Setup” menu with the CHANNEL selector knob.
3. Press the [ENT] key.
4. Turn the CHANNEL selector knob to select “UTC” or “Local.”
5. Press the [ENT] key to store the selected setting.
6. To exit this menu and return to radio operation mode press the [16/9] key.

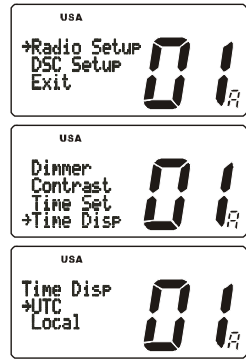

In the local time mode, the display shows the time by the 12-hour system. Meanwhile, the display shows the time by the 24-hour system in the UTC mode.

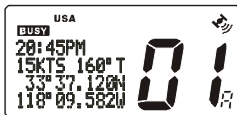

(“UTC” mode)

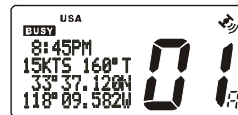

(“LOCAL” mode)

## 8.8 CHANGING COG TO TRUE OR MAGNETIC

Allows customizing the NAV data showing GPS Course Over Ground (COG). Factory default is True however following the steps below the COG can be changed to Magnetic.

1. Press and hold down the [CALL(MENU)] key until “Radio Setup” menu appears.
2. Press the [ENT] key, then select “Magnetic” with the CHANNEL selector knob.
3. Press the [ENT] key.
4. Turn the CHANNEL selector knob to select “On” (representing “Magnetic”) or “Off” (representing “True”).
5. Press the [ENT] key to store the selected setting.
6. Turn the CHANNEL selector knob to select “Exit,” then press the [ENT] key to return to the “Radio Setup” menu, select “Exit” and press the [ENT] key to return to radio operation.

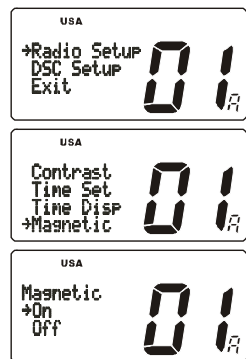

## 8.9 OPTIONAL MMB-84 FLUSH MOUNT INSTALLATION

1. To assist in flush mounting, a template has been included. Use this template to find the mounting location.
2. Use the template to mark the location where the rectangular hole is to be cut. Confirm the space behind the dash or panel is deep enough to accommodate the transceiver (at least 6 inches or 15 cm deep). There should be at least 1/2 inch (1.3 cm) between the transceiver's heatsink and any wiring, cables or structures.
3. Cut out the rectangular hole and insert the transceiver.
4. Fasten the brackets to the sides of the transceiver with the lock washer nut combination; so that the mounting screw base faces the mounting surface (see Figure 2).
5. Turn the adjusting screw to adjust the tension so that the transceiver is tight against the mounting surface.

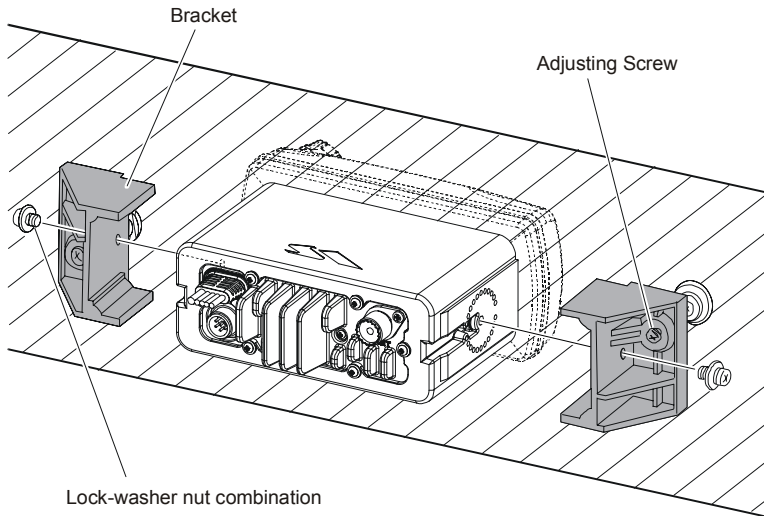

**Figure 2. MMB-84 Flush Mount Installation**

## 8.10 OPTIONAL ENHANCED RAM+ SECOND STATION MIC AND/OR VH-310 HANDSET INSTALLATION

The **GX1500S** is capable of using a Enhanced RAM+ mic or **VH-310** Handset to remotely control the Radio, DSC, and Distress functions. In addition the **GX1500S** can operate as a full function intercom system.

1. Connect the Routing Cable to the Remote Mic eight pin connector on the rear panel, then tighten the Cable Nut (See Figure 3).
2. Referring to Figure 4, make a 1.2" (30 mm) hole in the wall, then insert the Routing Cable into this hole. Connect the Gasket and Mount Base to the Routing Cable Connector using the Nut.
3. Drill the four Screw holes (approx. 2 mm) on the wall, then install the Mounting Base to the wall using four screws.
4. Put the Rubber Cap on to the Nut. The installation is now complete.
5. Wires for a external speaker are provided on the Routing Cable. Connect any 8 Ohm external speaker. When connected the RAM+ (or **VH-310** Handset) controls the volume level of this speaker.

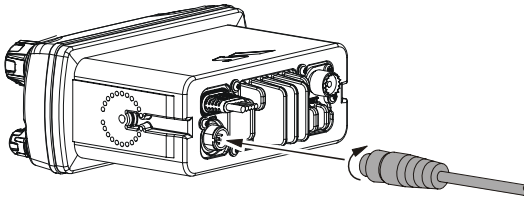

Figure 3

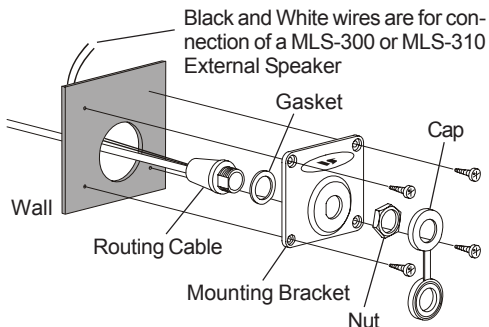

Figure 4



## Remote Mic or External Speaker Selection

By default the RAM+ or **VH-310** Handset internal speaker is turned on, however using the RAM+ mic (or **VH-310** Handset) this speaker can be turned off so the external speaker can be used.

### **RAM+ mic procedure**

1. Press and hold the **[CALL/SET]** key.
2. Press the **[▲]** or **[▼]** key to select “**RADIO SETUP.**”
3. Press the **[CALL/SET]** key.
4. Press the **[▼]** key to until “**EXT SPK**” is shown and press the **[CALL/SET]** key.
5. Press the **[▲]** or **[▼]** key to select “**oF**” (External speaker off) or “**on**” (External speaker on).
6. Press the **[CALL/SET]** key to save the selection.
7. Press the **[16/9]** key to exit this mode.



### **VH-310 Procedure**

1. Press and hold the **[CALL(MENU)]** key.
2. Press the **[▲]** or **[▼]** key to select “**RADIO SETUP.**”
3. Press the **[ENT]** key
4. Press the **[▼]** key to until “**EXT SPK**” is shown and press the **[ENT]** key.
5. Press the **[▲]** or **[▼]** key to select “**oF**” (External speaker off) or “**on**” (External speaker on).
6. Press the **[ENT]** key to save the selection.
7. Press the **[16/9]** key to exit this mode.

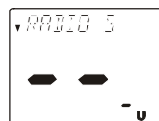

## 9 CONTROLS AND INDICATORS

### NOTE

This section defines each control of the transceiver. See Figure 4 for location of controls. For detailed operating instructions refer to section “10 BASIC OPERATION.”

#### ① CHANNEL SELECTOR KNOB

The rotary knob is used to select channels and to choose menu items (such as the DSC menu, radio setup menu, and DSC setup menu). The [UP(▲)] / [DOWN(▼)] keys on the microphone can also be used to select channels and menu items.

##### **Secondary Use**

While holding down the [SCAN] key and turning the **CHANNEL** selector knob, you can confirm memory channels for scanning.

#### ② [WX] Key

Immediately recalls the previously selected NOAA weather channel from any channel.

##### **Secondary use**

Holding down the [16/9] key while pressing the [WX] key changes from USA, International and Canadian channel groups.

#### ③ [16/9] Key

Immediately recalls channel 16 from any channel location. Holding down this key recalls channel 9. Pressing the [16/9] key again reverts to the previous selected working channel.

##### **Secondary use**

Press and hold the [16/9] key then press the [WX] key to switch the Channel Group.

#### ④ POWER SWITCH / VOLUME CONTROL (VOL/PWR)

Turns the transceiver on and off as well as adjusts the audio volume.

Press and hold this knob for one second to turn the radio on. Clockwise rotation of this knob increases the audio volume level.

Press and hold this knob for two seconds to turn the radio off.

#### ⑤ SQUELCH CONTROL (SQL)

Adjusting this control clockwise, sets the point at which random noise on the channel does not activate the audio circuits but a received signal does. This point is called the squelch threshold. Further adjustment of the squelch control will degrade reception of wanted transmissions.

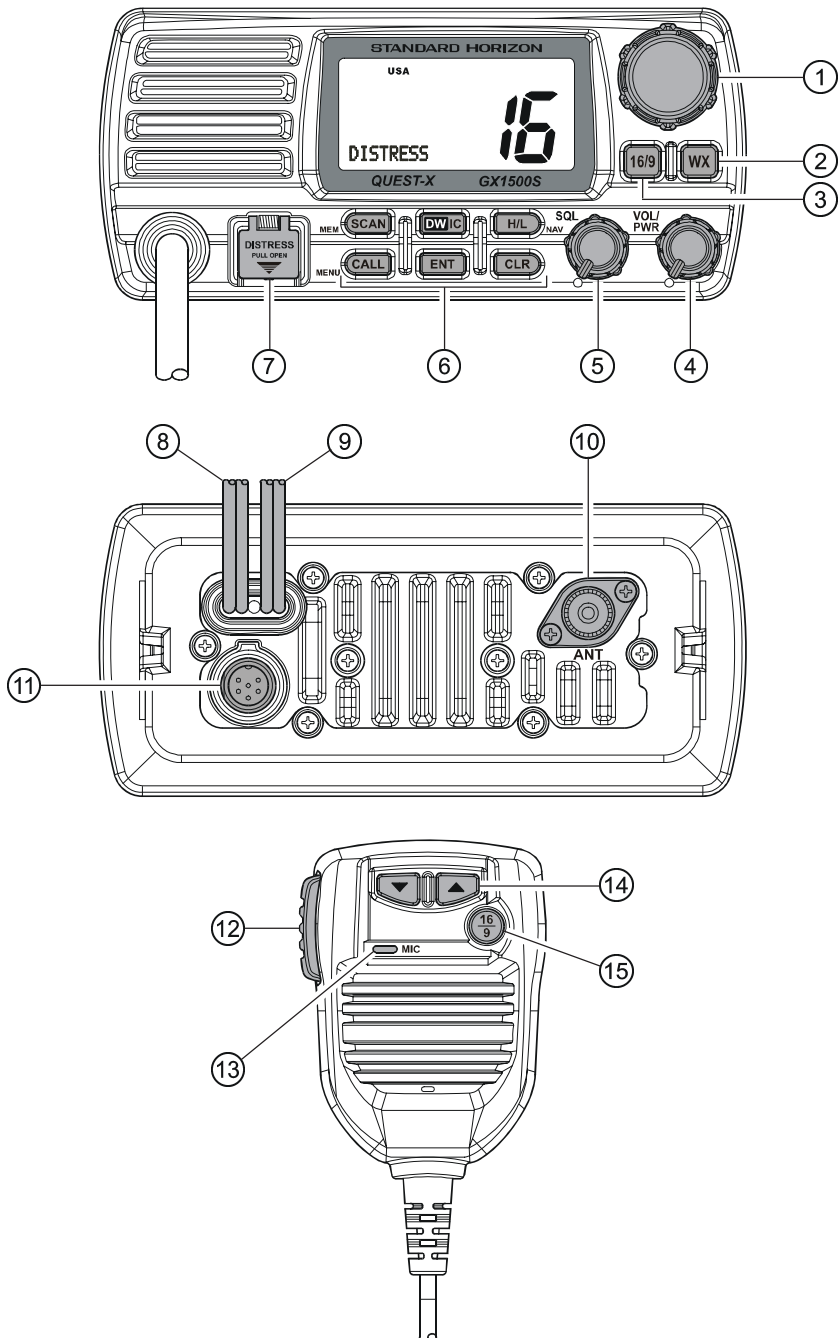

Figure 4. Controls and Connectors

## ⑥ KEYPAD

### [SCAN(MEM)] Key

Press this key to start and stop the scanning of programmed channels. Refer to section “**10.12 SCANNING**” for details.

#### **Secondary use**

To memorized a channel into scan memory, select the channel and press and hold the [SCAN(MEM)] key until “MEM” is shown on the display.

To delete a memorized channel from scan memory, select the channel and press and hold the [SCAN(MEM)] key until “MEM” is removed from the display.

### [DW/IC)] Key

Pressing this key enable dual watch between a priority channel (Ch16 is the default) and a selected channel until a signal is recieved. When a signal is recieved on the selected channel the radio will momentarily switch to the Priority channel and listen for communications. Refer to section “**10.11 DUAL WATCH (TO PRIORITY CHANNEL)**” for details.

#### **Secondary use**

Press and hold this key, when the optional RAM+ Mic or **VH-310** Handset is connected, intercom operation will operate between radio and option mic or handset. Refer to section “**10.14 INTERCOM OPERATION**” for details.

### [H/L(NAV)] Key

Press this key to toggle the transmit output power between 25 W (High) and 1 W (Low) power. When the [H/L(NAV)] key is pressed while the transceiver is on channel 13 or 67, the power will temporarily switch from LO to HI power until the **PTT** is released.

The [H/L(NAV)] key does not function on transmit inhibited and low power only channels.

**NOTE:** 1W low power is indicated by LO on the display, when 25W high power is selected the display do not show an indication.

#### **Secondary use**

Press and hold this key, the LCD displays NAV GPS Data, Time, SOG (Speed Over Ground), and COG (Course Over Ground) when a GPS is connected to the accessory cable of the **GX1500S**. See section “**8.4 CONNECTION OF GPS WITH NMEA OUTPUT**” for details.

### [CALL(MENU)] Key

Press the [CALL(MENU)] key to access the DSC OPERATION menu. The “INDIVIDUAL CALL,” “GROUP CALL,” and “ALL SHIPS CALL” functions can be accessed from the DSC OPERATION menu.

**NOTE:** Before the DSC OPERATION menu can be selected a MMSI must be entered. Refer to section “11.2 MARITIME MOBILE SERVICE IDENTITY (MMSI).”

#### **Secondary use**

Press and hold the [CALL(MENU)] key to access the “Radio Setup” (refer to section “12 RADIO SETUP MODE”) or “DSC Setup” menu (refer to section “11 DIGITAL SELECTIVE CALLING”).

### [ENT] Key

Press the [ENT] Key to determine the menu selection.

### [CLR] Key

Press the [CLR] Key to cancel the menu selection.

### ⑦ [DISTRESS] Key

Used to send a DSC Distress Call. To send the distress call refer to section “11.3.1 (Transmitting A DSC Distress Call).”

### ⑧ ACCESSORY CONNECTION CABLE

Connects the **GX1500S** to a GPS and an external speaker.

### ⑨ DC INPUT CABLE

Connects the radio to a DC power supply capable of delivering 12V DC.

### ⑩ ANTENNA JACK

Connects an antenna to the transceiver. Use a marine VHF antenna with an impedance of 50 ohms.

### ⑪ REMOTE MIC CONNECTOR

Connects the **GX1500S** to the enhanced RAM+ MIC (Remote Access Microphone) or the **VH-310** Handset. Refer to section “13 ENHANCED RAM+ MIC OPERATION” or “14 VH-310 HEADSET OPERATION” for details.

### ⑫ PTT (Push-To-Talk) SWITCH

Keys the transmitter when the transceiver is in radio mode. If the transceiver is in the intercom mode (between the RAM+ or **VH-310** Headset and the **GX1500S**), or PA mode, it activates the **GX1500S** microphone for voice communications.

⑬ **MICROPHONE**

Transmits the voice message with reduction of background noise, using Clear Voice Noise Reduction Technology.

**NOTE:** Be sure your mouth is about 1/2 inch from the mic hole for best performance.

⑭ **[UP(▲)] / [DOWN(▼)] KEYS**

The [UP(▲)] and [DOWN(▼)] on the microphone function the same as the **CHANNEL** selector knob on the front panel of the transceiver.

⑮ **[16/9] Key**

The [16/9] key on the microphone function the same as the [16/9] key on the front panel of the transceiver.

Immediately recalls channel 16 from any channel location. Holding down this key recalls channel 9. Pressing the [16/9] key again reverts to the previous selected working channel.

**MEMO**

Lined area for writing notes, consisting of multiple horizontal dashed lines.



## 10 BASIC OPERATION

### 10.1 RECEPTION

1. After the transceiver has been installed, ensure that the power supply and antenna are properly connected.
2. Press and hold the **VOL/PWR** knob until the radio turns on.
3. Turn the **SQL** knob fully counterclockwise. This state is known as “squelch off”.
4. Turn up the **VOL** knob until noise or audio from the speaker is at a comfortable level.
5. Turn the **SQL** knob clockwise until the random noise disappears. This state is known as the “squelch threshold.”
6. Turn the **CHANNEL** selector knob to select the desired channel. Refer to the channel chart on page 83 for available channels.
7. When a message is received, adjust the volume to the desired listening level. The “**BUSY**” indicator in the LCD is displayed indicating that the channel is being used.

### 10.2 TRANSMISSION

1. Perform steps 1 through 6 of RECEPTION.
2. Before transmitting, monitor the channel to ensure it is clear.  
**THIS IS AN FCC REQUIREMENT!**
3. Press the **PTT** (push-to-talk) switch. The “**TX**” indicator in the LCD is displayed.
4. Speak slowly and clearly into the microphone.
5. When the transmission is finished, release the **PTT** switch.

#### NOTE

This is a noise-canceling microphone. The oval slot on the bottom of microphone should be positioned within 1/2 inch (1.3 cm) from the mouth for optimum performance.

### 10.3 TRANSMIT TIME - OUT TIMER (TOT)

When the **PTT** switch on the microphone is held down, transmit time is limited to 5 minutes. This limits unintentional transmissions due to a stuck microphone. About 10 seconds before automatic transmitter shutdown, a warning beep will be heard from the speaker(s). The transceiver will automatically go to receive mode, even if the **PTT** switch is continually held down. Before transmitting again, the **PTT** switch must first be released and then pressed again.



## 10.4 SIMPLEX/DUPLEX CHANNEL USE

Refer to the VHF MARINE CHANNEL CHART (page 83) for instructions on use of simplex and duplex channels.

### NOTE

All channels are factory-programmed in accordance with International, Industry Canada (Canada), and FCC (USA) regulations. Mode of operation cannot be altered from simplex to duplex or vice-versa.

## 10.5 INTERNATIONAL, USA, AND CANADA MODE

1. To change the modes, hold the [**16/9**] key and press the [**WX**] key. The mode changes from International to Canadian to USA with each press of the [**WX**] key.
2. “**INTL**” will be displayed for International mode, “**CAN**” will be displayed for Canadian mode, and “**USA**” will be displayed on the LCD for USA mode.
3. Refer to the VHF MARINE CHANNEL CHART (page 83) for allocated channels in each mode.

## 10.6 NOAA WEATHER CHANNELS

### NOTE

NOAA Weather channels are available in the waters of USA and Canada only.

1. To receive a NOAA weather channel, press the [**WX**] key from any channel. The transceiver will go to the last selected weather channel.
2. Turn the **CHANNEL** selector knob on the radio or [**UP(▲)**] / [**DOWN(▼)**] keys on the microphone to select a different NOAA weather channel.
3. To exit from the NOAA weather channels, press the [**WX**] key. The transceiver returns to the channel it was on prior to a weather channel.

### 10.6.1 NOAA Weather Alert

In the event of extreme weather disturbances, such as storms and hurricanes, the NOAA (National Oceanic and Atmospheric Administration) sends a weather alert accompanied by a 1050 Hz tone and subsequent weather report on one of the NOAA weather channels. When the Weather Alert feature is enabled (see section “**12.9 WX ALERT**”), the transceiver is capable of receiving this alert if the following is performed:

1. Program NOAA weather channels into the transceiver’s memory for scanning. Follow the same procedure as for regular channels under section “**10.12 SCANNING**.”
2. Press the [**SCAN**] key once to start memory scanning or priority scanning (determined from the “**Radio Setup**” selection, see page 56 for details).

3. The programmed NOAA weather channels will be scanned along with the regular-programmed channels. However, scanning will not stop on a normal weather broadcast unless a NOAA alert is received.
4. When an alert is received on a NOAA weather channel, scanning will stop and the transceiver will emit a loud beep to alert the user of a NOAA broadcast.
5. Press the [WX] key to stop the alert tone and receive the weather report.

#### NOTE

If the [WX] key is not pressed the alert tone will be emitted for 5 minutes and then the weather report will be received.

#### NOTE

The Weather Alert feature is also engaged while the transceiver is receiving on one of the NOAA weather channels.

### 10.6.2 NOAA Weather Alert Testing

NOAA tests the alert system every Wednesday between 11AM and 1PM. To test the **GX1500S**'s NOAA Weather alert feature, on Wednesday between 11AM and 1PM, setup as in previous section and confirm the alert is heard.

### **10.7 EMERGENCY (CHANNEL 16 USE)**

Channel 16 is known as the Hail and Distress Channel. An emergency is defined as a threat to life or property. In such instances, be sure the transceiver is on and set to CHANNEL 16. Then use the following procedure:

1. Press the microphone push-to-talk switch and say "**Mayday, Mayday, Mayday**. This is \_\_\_\_\_, \_\_\_\_\_, \_\_\_\_\_" (your vessel's name).
2. Then repeat once: "**Mayday, \_\_\_\_\_**" (your vessel's name).
3. Now report your position in latitude/longitude, or by giving a true or magnetic bearing (state which) to a well-known landmark such as a navigation aid or geographic feature such as an island or harbor entry.
4. Explain the nature of your distress (sinking, collision, aground, fire, heart attack, life-threatening injury, etc.).
5. State the kind of assistance your desire (pumps, medical aid, etc.).
6. Report the number of persons aboard and condition of any injured.
7. Estimate the present seaworthiness and condition of your vessel.
8. Give your vessel's description: length, design (power or sail), color and other distinguishing marks. The total transmission should not exceed 1 minute.
9. End the message by saying "**OVER.**" Release the microphone button and listen.
10. If there is no answer, repeat the above procedure. If there is still no response, try another channel.

## 10.8 CALLING ANOTHER VESSEL (CHANNEL 16 OR 9)

Channel 16 may be used for initial contact (hailing) with another vessel.

However, its most important use is for emergency messages. This channel must be monitored at all times except when actually using another channel.

It is monitored by the U.S. and Canadian Coast Guards and by other vessels.

**Use of channel 16 for hailing must be limited to initial contact only.** Calling should not exceed 30 seconds, but may be repeated 3 times at 2-minute intervals. In areas of heavy radio traffic, congestion on channel 16 resulting from its use as a hailing channel can be reduced significantly in U.S. waters by using **channel 9** as the initial contact (hailing) channel for non-emergency communications. Here, also, calling time should not exceed 30 seconds but may be repeated 3 times at 2-minute intervals.

Prior to making contact with another vessel, refer to the channel charts in this manual, and select an appropriate channel for communications after initial contact. For example, Channels 68 and 69 are some of the channels available to non-commercial (recreational) boaters. Monitor your desired channel in advance to make sure you will not be interrupting other traffic, and then go back to either channel 16 or 9 for your initial contact.

When the hailing channel (16 or 9) is clear, state the name of the other vessel you wish to call and then **“this is”** followed by the name of your vessel and your Station License (Call Sign). When the other vessel returns your call, immediately request another channel by saying **“go to,”** the number of the other channel, and **“over.”** Then switch to the new channel. When the new channel is not busy, call the other vessel.

After a transmission, say **“over,”** and release the microphone’s push-to-talk (PTT) switch. When all communication with the other vessel is completed, end the last transmission by stating your Call Sign and the word **“out.”** Note that it is not necessary to state your Call Sign with each transmission, only at the beginning and end of the contact.

Remember to return to Channel 16 when not using another channel. Some radios automatically monitor Channel 16 even when set to other channels or when scanning.

## 10.9 MAKING TELEPHONE CALLS

To make a radiotelephone call, use a channel designated for this purpose. The fastest way to learn which channels are used for radiotelephone traffic is to ask at a local marina. Channels available for such traffic are designated **Public Correspondence** channels on the channel charts in this manual. Some examples for USA use are Channels 24, 25, 26, 27, 28, 84, 85, 86, and 87. Call



the marine operator and identify yourself by your vessel's name, The marine operator will then ask you how you will pay for the call (telephone credit card, collect, etc.) and then link your radio transmission to the telephone lines.

The marine telephone company managing the VHF channel you are using may charge a link-up fee in addition to the cost of the call.

## 10.10 OPERATING ON CHANNELS 13 AND 67

Channel 13 is used at docks and bridges and by vessels maneuvering in port. Messages on this channel must concern navigation only, such as meeting and passing in restricted waters.

Channel 67 is used for navigational traffic between vessels.

By regulation, power is normally limited to 1 Watt on these channels. Your radio is programmed to automatically reduce power to this limit on these channels. However, in certain situations it may be necessary to temporarily use a higher power. See page 20 ([H/L(NAV)] key) for means to temporarily override the low-power limit on these two channels.

## 10.11 DUAL WATCH (TO PRIORITY CHANNEL)

Dual watch allows the radio to monitor one channel and the assigned Priority channel. By default the priority channel is set to 16, however the priority channel may be changed by referring to section "12.6 PRIORITY CHANNEL SET."

1. Adjust the **SQL** knob until the background noise disappears.
2. Select the channel you wish to dual watch to "Priority channel."
3. Press the [DW(IC)] key.

The display will scan between Priority channel and the channel that was selected in step 2.

If a transmission is received on the channel selected in step 2, the **GX1500S** will dual watch between the working channel and the Priority channel.



4. To stop Dual Watch, press the [DW(IC)] key again.

## 10.12 SCANNING

Allows the user to select the scan type from Memory scan or Priority scan. “Memory scan” scans the channels that were programmed into memory. “Priority scan” scans the channels programmed in memory with the priority channel.

### 10.12.1 Selecting the Scan Type

1. Press and hold down the [CALL(MENU)] key until “Radio Setup” menu appears.
2. Press the [ENT] key, then select “SCAN Type” in the “Radio Setup” menu with the CHANNEL selector knob.
3. Press the [ENT] key.
4. Turn the CHANNEL selector knob to select “Priority” or “Memory.”
5. Press the [ENT] key to store the selected setting.
6. To exit this menu and return to radio operation mode press the [16/9] key.

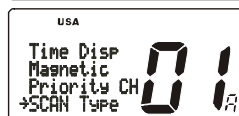

### 10.12.2 Memory Scanning (M-SCAN)

1. Adjust the SQL knob until background noise disappears.
2. Select a desired channel to be scanned using the CHANNEL selector knob. Press and hold the [SCAN(MEM)] key for one second, “MEM” will appear on the LCD which indicates the channel has been programmed into the transceivers memory.
3. Repeat step 2 for all the desired channels to be scanned.
4. To DELETE a channel from the transceiver’s memory, select the channel then press and hold the [SCAN(MEM)] key for one second, “MEM” will disappear in the LCD.
5. To start scanning, just press the [SCAN(MEM)] key momentarily. “M-SCAN” appears on the LCD. Scanning will proceed from the lowest to the highest programmed channel number and will stop on a channel when a transmission is received.
6. The channel number will blink during reception.
7. To stop scanning, press the [16/9] or [WX] key.

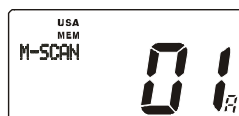
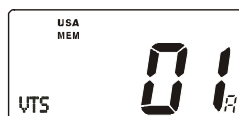

### 10.12.3 Priority Scanning (P-SCAN)

In the default setting, Channel 16 is set as the priority channel. You may change the priority channel to the desired channel from the Channel 16 by the Radio Setup Mode, refer to section “12.6 PRIORITY CHANNEL SET.”

1. Adjust the **SQL** knob until background noise disappears.
2. Select a desired channel to be scanned using the **CHANNEL** selector knob. Press and hold the [**SCAN(MEM)**] key for one second, “**MEM**” will appear on the display which indicates the channel has been programmed into the transceivers memory.
3. Repeat step 2 for all the desired channels to be scanned.
4. To **DELETE** a channel from the transceiver’s memory, select the channel then press and hold the [**SCAN(MEM)**] key until “**MEM**” is removed from the display.
5. To start priority scanning, just press the [**SCAN(MEM)**] key momentarily. “**P-SCAN**” appears on the LCD. Scanning will proceed between the memorized channels and the priority channel. The priority channel will be scanned after each programmed channel.
6. To stop scanning, press the [**16/9**] or [**WX**] key.



You may change the scan resume time in the Radio Setup Mode, refer to section “12.8 SCAN RESUME TIME.”

### 10.13 NAVIGATION INDICATION

The transceiver has the ability to display Time, SOG, COG, as well as the position (LAT/LON), when connected to a GPS receiver.

1. Press and hold the [**H/L(NAV)**] key, display the position information on the LCD. If the GPS receiver is not receiving a fix, the display will be as shown in the illustration on the right.  
**NOTE:** When Ch16 is selected only lat/lon will shown.
2. To hide the position information, press and hold the [**H/L(NAV)**] key again.

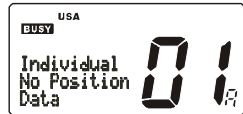
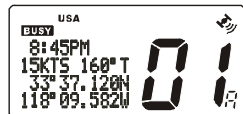

## 10.14 INTERCOM OPERATION

Connecting a CMP25 RAM+ or VH-310 handset to the GX1500S allows intercom communications. Refer to section “13.2 INTERCOM OPERATION” for **CMP25 RAM+ Microphone** or section “14.2 INTERCOM OPERATION” for **VH-310 Handset**.

### 10.14.1 Communication

1. Press and hold the **[DW(IC)]** key, the mode is changed to “INTERCOM” mode.
2. When the “INTERCOM” is activated, “Intercom” is displayed on the **GX1500S**, and “IC” is displayed on the RAM+ Mic or **VH-310** Handset.



3. Press the **PTT** switch. “Talk” will be shown on the display.

**NOTE:** A warning beep will be emitted when the **GX1500S** microphone’s **PTT** switch is pressed while the RAM+ Mic’s or **VH-310** Handset’s **PTT** switch is pressed.



(GX1500S's PTT switch is pressed)

4. Speak slowly and clearly into the microphone, hold the microphone about 1/2 inch away from your mouth.



(RAM+ Mic's PTT switch is pressed)

5. When finished, release the **PTT** switch.
6. To exit the “INTERCOM” mode and return to radio operation mode, press the **[16/9]** or **[CLR]** key.

### 10.14.2 Calling

While in INTERCOM mode, pressing and holding the **[DW(IC)]** key on the **GX1500S**, **CMP25** or **VH-310** will produce a calling beep [at the other station].

# 11 DIGITAL SELECTIVE CALLING

## 11.1 GENERAL

### WARNING

This radio is designed to generate a digital maritime distress and safety call to facilitate search and rescue. To be effective as a safety device, this equipment must be used only within communication range of a shore-based VHF marine channel 70 distress and safety watch system. The range of signal may vary but under normal conditions should be approximately 20 nautical miles.

### NOTE

A DSC Warning sticker is included with the **GX1500S**. To comply with FCC regulations this sticker must be mounted in a location that can be easily viewed from the location of the **GX1500S**. Make sure the chosen location is clean and dry before applying the sticker.

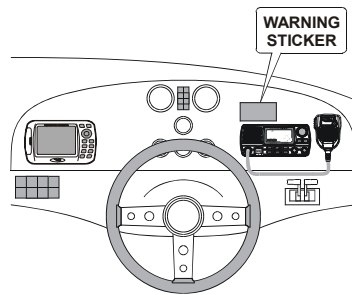

Digital Selective Calling is a semi-automated method of establishing a radio call, it has been designated by the International Maritime Organization (IMO) as an international standard for establishing VHF, MF, and HF radio calls. It has also been designated as part of the Global Maritime Distress and Safety System (GMDSS). It is planned that DSC will eventually replace aural watches on distress frequencies and will be used to announce routine and urgent maritime safety information broadcasts.

This new system allows mariners to instantly send a distress call with GPS position (when connected to the transceiver) to the Coast Guard and other vessels within range of the transmission. DSC will also allow mariners to initiate or receive Distress, Urgency, Safety, Routine, POSITION REQUEST, POSITION SEND, and Group calls to or from another vessel equipped with a DSC transceiver.

## 11.2 MARITIME MOBILE SERVICE IDENTITY (MMSI)

### 11.2.1 What is an MMSI?

An MMSI is a nine digit number used on Marine Transceivers capable of using Digital Selective Calling (DSC). This number is used like a telephone number to selectively call other vessels.



# THIS NUMBER MUST BE PROGRAMMED INTO THE RADIO TO OPERATE THE GX1500S DSC FUNCTIONS.

## How can I obtain an MMSI assignment?

Boat US offers online registration of a MMSI. Visit [www.boatus.com/mmsi](http://www.boatus.com/mmsi)

### 11.2.2 Programming the MMSI

#### WARNING

**User MMSI can be input only ONCE, please be careful not to input the incorrect MMSI number.** If you try to enter the MMSI more than one time, the radio will show the display to the right. If the MMSI number has been entered incorrectly, the transceiver will have to be sent to Factory Service to be reset. Refer to the section “**15.2. FACTORY SERVICE**” for the address.



When finished programming the MMSI number, press and hold the [ENT] key until the confirmation message appears, then press the [ENT] key to store the number in memory and return to radio operation mode.

If the user needs to change the MMSI number after it has been entered, the radio will have to be returned to Factory Service.

1. Press and hold down the [CALL(MENU)] key until the “Radio Setup” menu appears.
2. Turn the CHANNEL selector knob to the left to select “DSC Setup” menu.
3. Press the [ENT] key, then select “User MMSI” with the CHANNEL selector knob.
4. Press the [ENT] key. The display will show a series of dashes or the last MMSI number if programmed.
5. Turn the CHANNEL selector knob or press the [UP(▲)] / [DOWN(▼)] key on the microphone to select the first number of your MMSI, then press the [ENT] key to step to the next number.
6. Repeat step 5 to set your MMSI (up to nine digits).
7. When finished programming the number, press and hold the [ENT] key to show the display at the right.
8. Press the [ENT] key to save the MMSI number into memory.
9. To exit this menu and return to radio operation mode press the [16/9] key.

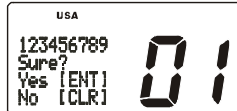
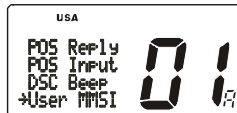

## 11.3 DSC DISTRESS CALL

The **GX1500S** is capable of transmitting and receiving DSC Distress messages to all DSC radios. The **GX1500S** may be connected to a GPS to also transmit the Latitude, Longitude of the vessel.

### 11.3.1 Transmitting a DSC Distress Call

#### NOTE

To be able to transmit a DSC distress call an MMSI number must be programmed, refer to section “11.2.2 Programming the MMSI.”

In order for your ships location to be transmitted a GPS must be connected to the **GX1500S**, refer to section “8.4 CONNECTION OF GPS WITH NMEA OUTPUT.”

1. Lift the red spring loaded DISTRESS cover and press the [DISTRESS] key. The “DISTRESS” menu will appear on the LCD.
2. Press and hold the [DISTRESS] key. The radios display will count down (3-2-1) and then transmit the Distress call.
3. When the distress signal is sent, CH70 and “TX” icon will appear on the LCD. After the message has been sent, the radio will sound a Distress Alarm and display will flash.
4. The transceiver will watch for a DSC acknowledgment transmission on CH70 and also receive calls on CH16.
5. If an acknowledgement is received, select channel 16 and advise your distress situation.
6. If no acknowledgment is received, the distress call is repeated in 4 minute intervals until a DSC acknowledgment is received.
7. When a DSC Distress acknowledgment is received, a distress alarm sounds and channel 16 is automatically selected. The LCD shows the MMSI of the ship responding to your distress.  
RECEIVED ACK: acknowledgment signal is received.  
RECEIVED RLY: relay signal is received from another vessel or coast station.
8. To cancel the DSC distress alarm signal from the speaker, press any key.

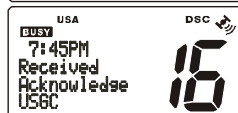
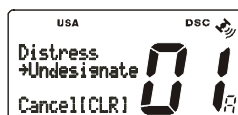

Transmitting a DSC Distress Call with Nature of Distress

The **GX1500S** is capable of transmitting a DSC Distress Call with the following “Nature of Distress” categories:

Undesignated, Fire, Flooding, Collision, Grounding, Capsizing, Sinking, Adrift, Abandoning, Piracy, Mob

1. Lift the red spring loaded DISTRESS cover and press the **[DISTRESS]** key. The “**DISTRESS**” menu will appear on the LCD.
2. Turn the **CHANNEL** selector knob to select the desired nature of distress category.
3. Press and hold the **[DISTRESS]** key. The radios display will count down (3-2-1) and then transmit the Distress call.
4. When the distress signal is sent, CH70 and “**TX**” icon will appear on the LCD. After the message has been sent, the radio will sound a Distress Alarm and display will flash.

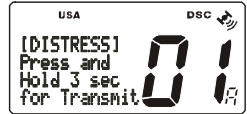
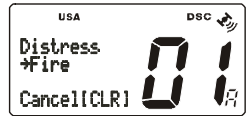
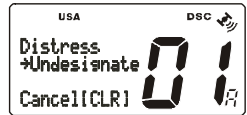

5. The transceiver will watch for a DSC acknowledgment transmission on CH70 and also receive calls on CH16.
6. If an acknowledgement is received, select channel 16 and advise your distress situation.
7. If no acknowledgment is received, the distress call is repeated in 4 minute intervals until a DSC acknowledgment is received.



8. When a DSC Distress acknowledgment is received, a distress alarm sounds and channel 16 is automatically selected. The LCD shows the MMSI of the ship responding to your distress.

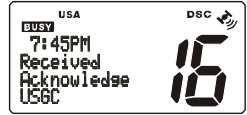

RECEIVED ACK: acknowledgment signal is received.

RECEIVED RLY: relay signal is received from another vessel or coast station.

9. To cancel the DSC distress alarm signal from the speaker, press any key.

Cancel a DSC Distress Call

If a DSC Distress call was sent by error the **GX1500S** allows you to send a message to other vessels to cancel the Distress Call that was made in error.

Press the **[CLR]** key, then press the **[ENT]** key.

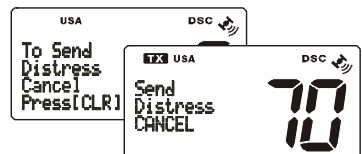

### 11.3.2 Receiving a DSC Distress Call

1. When a DSC Distress call is received, an emergency alarm sounds.  
Then channel 16 is automatically selected.
2. Press any key to stop the alarm.
3. Turn the **CHANNEL** selector knob to change the display to show the position of the vessel in distress.
4. If the position of the vessel distress data does not include position, the LCD will show the display on the right.



#### NOTE

You must continue monitoring channel 16 as a coast station may require assistance in the rescue attempt.

### 11.4 ALL SHIPS CALL

The All Ships Call function allows contact to be established with other vessel stations without having their ID in the individual calling directory. Also, priority for the call can be designated as Agency or Safety.

**URGENCY Call:** This type of call is used when a vessel may not truly be in distress, but have a potential problem that may lead to a distress situation. This call is the same as saying PAN PAN PAN on channel 16.

**SAFETY Call:** Used to transmit boating safety information to other vessels. This message usually contains information about an overdue boat, debris in the water, loss of a navigation aid or an important meteorological message. This call is the same as saying "Securite, Securite, Securite."

### 11.4.1 Transmitting an All Ships Call

1. Press the [CALL(MENU)] key. The “DSC Operation” menu will appear.
2. Turn the **CHANNEL** selector knob to select “All Ships.”
3. Press the [ENT] key. (To cancel, turn the **CHANNEL** selector knob to select “Exit.”)
4. Turn the **CHANNEL** selector knob to select the call (“Urgency” or “Safety”).
5. Press the [ENT] key to transmit the selected type of all ships DSC call.
6. After the ALL SHIPS CALL is transmitted, the transceiver will switch to CH16.
7. Listen to the channel to make sure it is not busy, then key the microphone and say PAN PAN PAN or “Securite, Securite, Securite” depending on the priority of the call. Say your call sign and announce the channel you wish to switch to for communications.



### 11.4.2 Receiving an All Ships Call

1. When an all ships call is received, an emergency alarm sounds.
2. Press any key to stop the alarm.
3. Turn the **CHANNEL** selector knob to see the MMSI of the vessel transmitting the All Ships Call.
4. Press the [ENT] key to change the operating channel to channel 16 (To cancel, press the [CLR] key).
5. Monitor channel 16 or traffic channel until the URGENCY voice communication is completed.



## 11.5 INDIVIDUAL CALL

This feature allows the **GX1500S** to contact another vessel with a DSC VHF radio and automatically switch the receiving radio to a desired communications channel. This feature is similar to calling a vessel on CH16 and requesting to go to another channel (switching to the channel is private between the two stations).

### 11.5.1 Setting up the Individual / Position Call Directory

The **GX1500S** has a DSC directory that allows you to store a vessel or person's name and the MMSI number associated with vessels you wish to transmit Individual calls, Position Requests and Position Send transmissions.

To transmit an Individual call you must program this directory with information of the persons you wish to call, similar to a cellular phones telephone directory.

1. Press and hold down the **[CALL(MENU)]** key until "Radio Setup" menu appears.
2. Turn the **CHANNEL** selector knob to select "DSC Setup" menu.
3. Press the **[ENT]** key, then select "INDIV DIR" with the **CHANNEL** selector knob.
4. Press the **[ENT]** key, then select "Add" with the **CHANNEL** selector knob.
5. Press the **[ENT]** key.
6. Turn the **CHANNEL** selector knob to scroll through the first letter of the name of the vessel or person you want to reference in the directory.
7. Press the **[ENT]** key to store the first letter in the name and step to the next letter to the right.
8. Repeat step 6 and 7 until the name is complete. The name can consist of up to eleven characters, if you do not use all eleven characters press the **[ENT]** key to move to the next space. This method can also be used to enter a blank space in the name. To clear the previous letter, press the **[CLR]** key.
9. After the eleventh letter or space has been entered, press and hold the **[ENT]** key to advance to the MMSI Maritime Mobile Service Identity Number number entry.
10. Turn the **CHANNEL** selector knob to scroll through numbers, 0-9. To enter the desired number and move one space to the right press the **[ENT]** key. Repeat this procedure until all nine space of the MMSI number are entered.



11. If a mistake was made entering in the name or the MMSI number repeat pressing the **[H/L(NAV)]** key until the wrong character is selected, then move the channel knob to correct the entry.
12. To store the data entered, press and hold the **[ENT]** key.
13. To enter another individual address, repeats steps 4 through 12.
14. To exit this menu and return to radio operation mode press the **[16/9]** key.

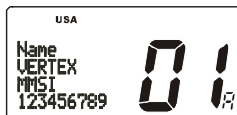

### NOTE

Selecting **“Next”** or **“Exit”** will automatically save the name and MMSI number into memory.

## 11.5.2 Setting up Individual Reply

Allows setting up the radio to automatically (default setting) or manually respond to a DSC Individual call requesting you to switch to a working channel for voice communications. When Manual is selected the MMSI of the calling vessel is shown allowing you to see who is calling. This function is similar to caller id on a cellular phone.

1. Press and hold down the **[CALL(MENU)]** key until **“Radio Setup”** menu appears.
2. Turn the **CHANNEL** selector knob to select **“DSC Setup”** menu.
3. Press the **[ENT]** key, then select **“INDIV Reply”** with the **CHANNEL** selector knob.
4. Press the **[ENT]**key.
5. Turn the **CHANNEL** selector knob to select **“Auto”** or **“Manual.”**
6. Press the **[ENT]** key to store the selected setting.
7. To exit this menu and return to radio operation mode press the **[16/9]** key.



### 11.5.3 Setting up the Individual/Group Call Ringer

When a Individual Call or Group Call is received the radio will produce a ringing tone for 3 minutes. This selection allows the Individual Call ringer time to be changed.

1. Press and hold down the [CALL(MENU)] key until “Radio Setup” menu appear.
2. Turn the CHANNEL selector knob to select “DSC Setup” menu.
3. Press the [ENT] key, then select “INDIV Ring” with the CHANNEL selector knob.
4. Press the [ENT] key.
5. Turn the CHANNEL selector knob to select ringing time of a Individual Call.
6. Press the [ENT] key to store the selected setting.
7. To exit this menu and return to radio operation mode press the [16/9] key.

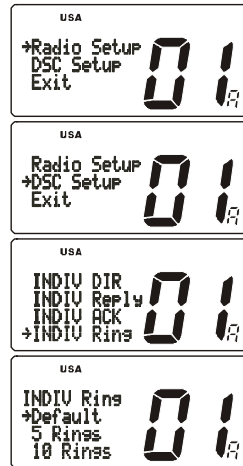

The **GX1500S** has the capability to turn off the Individual call ringer.

1. Press and hold down the [CALL(MENU)] key until “Radio Setup” menu appear.
2. Turn the CHANNEL selector knob to select “DSC Setup” menu.
3. Press the [ENT] key, then select “DSC Beep” with the CHANNEL selector knob.
4. Press the [ENT] key.
5. Turn the CHANNEL selector knob to select “Individual” if you wish to disable the Individual Call ringer, or “Group” if you wish to disable the Group Call ringer and press the [ENT] key.
6. Turn the CHANNEL selector knob to select “Off.”
7. Press the [ENT] key to store the selected setting.
8. To exit this menu and return to radio operation mode press the [16/9] key.



If you wish to return to enabling the ringer tone, just repeat the above procedure, turning the CHANNEL selector knob to select “On” in step “6” above.



## 11.5.4 Transmitting an Individual Call

This feature allows the user to contact another vessel with a DSC radio. This feature is similar to calling a vessel on CH16 and requesting to go to another channel.

### Pre-Programmable Calling

1. Press the [CALL(MENU)] key. The “DSC Operation” menu will appear.
2. Turn the **CHANNEL** selector knob to select “Individual.” (To cancel, select “Exit” with the **CHANNEL** selector knob or press the [16/9] key.)
3. Press the [ENT] key. The transceiver will beep, and the “Individual directory” will appear.
4. Turn the **CHANNEL** selector knob to select the “Individual” you want to contact.
5. Press the [ENT] key, then turn the **CHANNEL** selector knob to select the operating channel you want to communicate on and press the [ENT] key.
6. Press the [ENT] key again to transmit the individual DSC signal.
7. After INDIVIDUAL CALL is transmitted, the transceiver will wait 8 seconds for the acknowledgment. If the reply signal is not received, the display will be as shown in the illustration on the right.
8. After the second INDIVIDUAL CALL is transmitted, if the reply signal is not received, the display will be as shown in the illustration on the right. To send the call again, press the [ENT] key.
9. When an individual call acknowledgment is received, the established channel is automatically changed to the channel which is selected on step 5 above and a ringing tone sounds.
10. Press any key to listen to the channel to make sure it is not busy, then key the microphone and call the other vessel you desire to communicate with.

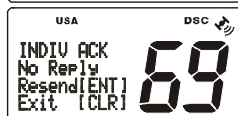
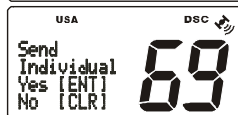
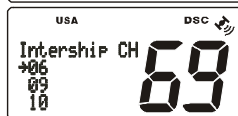
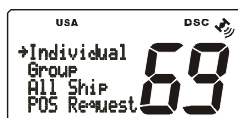

## Manual Calling

You may enter an MMSI number manually to contact without the Setting up the Individual Directory.

1. Press the [CALL(MENU)] key. The “DSC Operation” menu will appear.
2. Turn the **CHANNEL** selector knob to select “Individual.” (To cancel, select “Exit” with the **CHANNEL** selector knob or press the [16/9] key.)
3. Press the [ENT] key. The transceiver will beep, and the “Individual directory” will appear.
4. Turn the **CHANNEL** selector knob to select “Manual,” then press the [ENT] key.
5. Turn the **CHANNEL** selector knob to scroll through numbers, 0-9. To enter the desired number and move one space to the right press the [ENT] key. Repeat this procedure until all nine space of the MMSI number which you want to contact are entered.
6. If a mistake was made entering in the MMSI number repeat pressing the [H/L(NAV)] key until the wrong number is selected, then move the channel knob to correct the entry.
7. When finished entering the MMSI number, press and hold the [ENT] key.
8. Press the [ENT] key, then turn the **CHANNEL** selector knob to select the operating channel you want to communicate on and press the [ENT] key.
9. Press the [ENT] key again to transmit the individual DSC signal.
10. After INDIVIDUAL CALL is transmitted, the transceiver will wait 8 seconds for the acknowledgment. If the reply signal is not received, the transceiver will transmit again.
11. After the second INDIVIDUAL CALL is transmitted, if the reply signal is not received, the display will be as shown in the illustration on the right. To send the call again, press the [ENT] key or to exit the mode, press the [CLR] key.
12. When an individual call acknowledgment is received, the established channel is automatically changed to the channel which is selected on step 5 above and a ringing tone sounds.
13. Press any key to listen to the channel to make sure it is not busy, then key the microphone and call the other vessel you desire to communicate with.

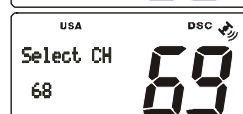
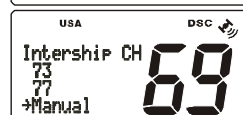
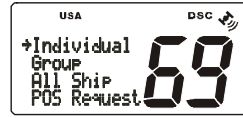

## 11.5.5 Receiving an Individual Call

When receiving an individual call, an acknowledgment must be sent back to the calling station. The **GX1500S** default setting is Automatic, but has a selection that allows you to manually send a reply before the radio will switch to the requested calling channel. This selection is useful if you want to see who is calling and requesting you to switch to a channel for communications, similar to caller id on a cellular phone.

1. When an individual call is received, an individual call ringing alarm sounds.
2. Press any key to stop the alarm.
3. Turn the **CHANNEL** selector knob to see the MMSI of the vessel transmitting the Individual Call.
4. Press the **[ENT]** key to change the operating channel to the requested channel (To cancel, press the **[CLR]** key).
5. Press the **PTT** on the mic and talk to the calling ship.

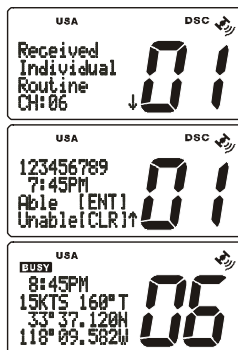

## 11.5.6 Call Waiting Directory

The **GX1500S** logs received distress calls and individual calls. The DSC Call Waiting feature is similar to an answer machine where calls are recorded for review. When a call is logged while the radio is set on the DSC Standby function, a message will appear on the LCD. The **GX1500S** can memorise the latest 23 Distress and up to the latest 56 DSC Calls.

### 11.5.6.1 Enabling/Disabling the Call Waiting Feature

Follow the steps below to enable or disable the Call Waiting feature.

1. Press and hold down the **[CALL(MENU)]** key until "Radio Setup" menu appears.
2. Turn the **CHANNEL** selector knob to select "DSC Setup" menu.
3. Press the **[ENT]** key, then select "INDIV ACK" with the **CHANNEL** selector knob.
4. Press the **[ENT]** key.
5. Turn the **CHANNEL** selector knob to select "Able" or "Unable."
6. Press the **[ENT]** key to store the selected setting.
7. To exit this menu and return to radio operation mode press the **[16/9]** key.

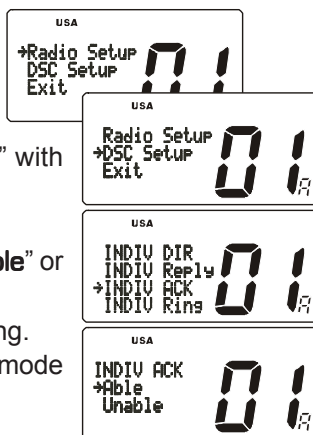

### 11.5.6.2 Reviewing Received Calls Logged into the Call Waiting Directory

1. Press the [CALL(MENU)] key. The “DSC Operation” menu will appear.
2. Turn the CHANNEL selector knob to select “DSC Log” menu.
3. Press the [ENT] key, then turn the CHANNEL selector knob to select the category (“Distress” or “DSC Call”) you want to review and/or call back.
4. Press the [ENT] key, then turn the CHANNEL selector knob to select the station (name or MMIS number) you want to review and/or call back.
5. Press the [ENT] key, to review details for the selected station.
6. Press the [ENT] key again, to call the selected station.

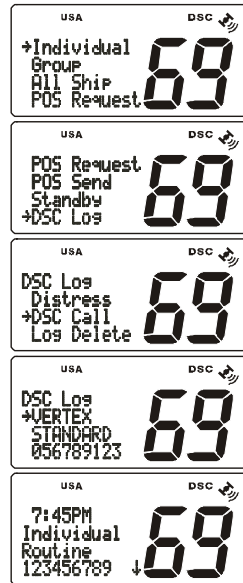

#### NOTE

When there is an unread received call, the category (“Distress” or “DSC Call”) notation will blink.

### 11.5.6.3 To Delete the Received Log from the “DSC Log” Directory

1. Press the [CALL(MENU)] key. The “DSC Operation” menu will appear.
2. Turn the CHANNEL selector knob to select “DSC Log” menu.
3. Press the [ENT] key, then turn the CHANNEL selector knob to select “Log Delete.”
4. Press the [ENT] key, then turn the CHANNEL selector knob to select the category (“Distress” or “DSC Call”) to be deleted.
5. Press the [ENT] key, then turn the CHANNEL selector knob to select the station (name or MMIS number) to be deleted.
6. Press and hold the [ENT] key until the station (name or MMIS number) is removed from the display.
7. To exit this menu and return to radio operation mode press the [16/9] key.

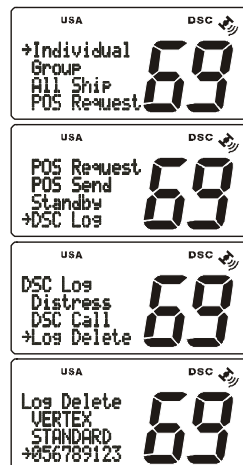

## 11.6 GROUP CALL

This feature allows the user to contact a group of specific vessels (example members of a yacht club) using DSC radios with Group call function to automatically switch to a desired channel for voice communications.

### 11.6.1 Setting up a Group Call

For this function to operate the same Group MMSI must be programmed into all the DSC VHF radios within the group of vessels that will be using this feature. The group MMSI is a 9 digit (first digit permanently set to “0”) number that will allow other radios to call your vessel along with others to automatically switch to a working channel for voice communications. This function is very useful for yacht clubs and vessels traveling together that want to collectively make announcements on a predetermined channel.

1. Press and hold down the **[CALL(MENU)]** key until “Radio Setup” menu appears.
2. Turn the **CHANNEL** selector knob to select “DSC Setup” menu.
3. Press the **[ENT]** key, then select “Group DIR” with the **CHANNEL** selector knob.
4. Press the **[ENT]** key, then select “Add” with the **CHANNEL** selector knob.
5. Press the **[CALL(MENU)]** key.
6. Turn the **CHANNEL** selector knob to scroll through the first letter of the name of the vessel or person you want to reference in the directory.
7. Press the **[ENT]** key to store the first letter in the name and step to the next letter to the right.
8. Repeat step 6 and 7 until the name is complete. The name can consist of up to eleven characters, if you do not use all eleven characters press the **[ENT]** key to move to the next space. This method can also be used to enter a blank space in the name. To clear the previous letter, press the **[CLR]** key.
9. After the eleventh letter or space has been entered, press and hold the **[ENT]** key to advance to the MMSI (Maritime Mobile Service Identity Number) number entry.
10. Turn the **CHANNEL** selector knob to scroll through numbers, 0-9. To enter the desired number and move one space to the right press the **[ENT]** key. Repeat this procedure until all nine space of the MMSI number are entered.

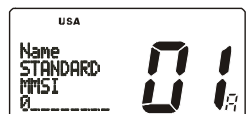
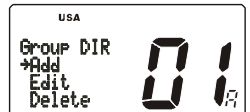

11. If a mistake was made entering in the name or the MMSI number repeat pressing the [H/L(NAV)] key until the wrong character is selected, then move the channel knob to correct the entry.
12. To store the data entered, press and hold the [ENT] key.
13. To enter another individual address, repeat steps 4 through 12.
14. To exit this menu and return to radio operation mode press the [16/9] key.



## 11.6.2 Transmitting a Group Call

### *Pre-Programmable Calling*

1. Press the [CALL(MENU)] key. The “DSC Operation” menu will appear.
2. Turn the **CHANNEL** selector knob to select “Group.” (To cancel, select “Exit” with the **CHANNEL** selector knob or press [16/9] key.)
3. Press the [ENT] key. The transceiver will beep, and the “Group Directory” will appear.
4. Turn the **CHANNEL** selector knob to select the “Group” you want to contact.
5. Press the [ENT] key, then turn the **CHANNEL** selector knob to select the operating channel you want to communicate on and press the [ENT] key.
6. Press the [ENT] key again to transmit the Group Call signal.
7. After the GROUP CALL is transmitted, all the radios in the group will switch to the designated channel.
8. Listen to the channel to make sure it is not busy, then key the microphone and call the other vessels you desire to communicate with.



Manual Calling

You may enter an MMSI number manually to contact without the Setting up the Group call number.

1. Press the [CALL(MENU)] key. The “DSC Operation” menu will appear.
2. Turn the CHANNEL selector knob to select “Group.” (To cancel, select “Exit” with the CHANNEL selector knob or press [16/9] key.)
3. Press the [ENT] key. The transceiver will beep, and the “Group Directory” will appear.
4. Turn the CHANNEL selector knob to select “Manual,” then press the [ENT] key.
5. Turn the CHANNEL selector knob to scroll through numbers, 0-9. To enter the desired number and move one space to the right press the [ENT] key. Repeat this procedure until all nine space of the MMSI number which you want to contact are entered.
6. If a mistake was made entering in the MMSI number repeat pressing the [H/L(NAV)] key until the wrong number is selected, then move the channel knob to correct the entry.
7. When finish the entering the MMSI number, press and hold the [ENT] key.
8. Press the [ENT] key to transmit the Group Call signal.
9. After the GROUP CALL is transmitted, all the radios in the group will switch to the designated channel.
10. Listen to the channel to make sure it is not busy, then key the microphone and call the other vessels you desire to communicate with.

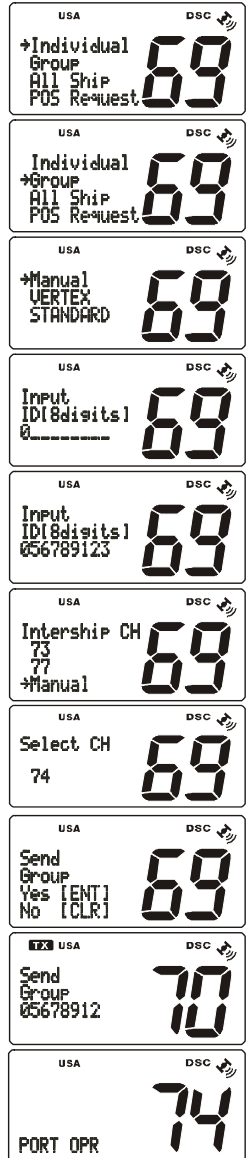

### 11.6.3 Receiving a Group Call

1. When a group call is received, the **GX1500S** will produce a ringing alarm sound.
2. Press any key to stop the alarm.
3. Turn the **CHANNEL** selector knob to see the MMSI of the vessel transmitting the Group Call.
4. Press the **[ENT]** key to change the operating channel to the requested channel (To cancel, press the **[CLR]** key).
5. Monitor the channel for the person calling the Group for a message.
6. If you want to respond, monitor the channel to make sure it is clear, then press the **PTT** on the mic and talk to the calling ship(s).

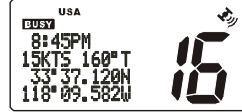
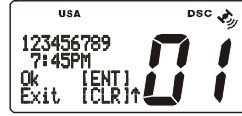

#### NOTE

After a Group call is received, the time the call was made and the ships MMSI or vessels name will appear on the LCD.



## 11.7 POSITION REQUEST

Advancements in DSC have made it possible to poll the location of another vessel and show the position of that vessel on the display of the **GX1500S**. Standard Horizon has taken this feature one step further, if any Standard Horizon GPS is connected to the **GX1500S**, the polled position of the vessel is shown on the display of the GPS chart plotter making it easy to navigate to the location of the polled vessel. This is a great feature for anyone wanting to know the position of another vessel. For example your buddy that is catching fish, or finding the location of a person you are cruising with.

### NOTE

The other vessel must have an operating GPS receiver connected to its DSC transceiver and must not have its transceiver set to deny position requests. (Refer the section “**11.5.1 Setting up the Individual / Position Call Directory**” to enter information into the individual directory).

### 11.7.1 Setting up Position Reply

The **GX1500S** can be set up to automatically or manually send your position to another vessel. This selection is important if you are concerned about someone polling the position of your vessel that you may not want to. In the manual mode you will see the MMSI or persons name shown on the display allowing you to choose to send your position to the requesting vessel.

1. Press and hold down the [CALL(MENU)] key until “**Radio Setup**” menu appear.
2. Turn the **CHANNEL** selector knob to select “**DSC Setup**” menu.
3. Press the [ENT] key, then select “**POS Reply**” with the **CHANNEL** selector knob.
4. Press the [ENT] key.
5. Turn the **CHANNEL** selector knob to select “**Auto**” or “**Manual**.” In “**Auto**” mode, after a DSC POS Request is received, the radio will automatically transmit your vessels position. In “**Manual**” mode, the display of the **GX1500S** will show who is requesting the position.
6. Press the [ENT] key to store the selected setting.
7. To exit this menu and return to radio operation mode press the [16/9] key.

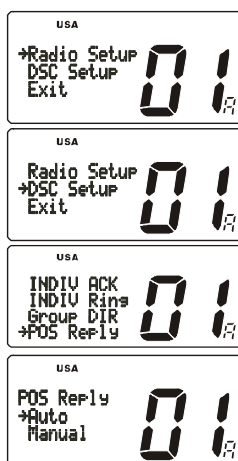

The **GX1500S** has the capability to turn off the Position Request ringer.

1. Press and hold down the [**CALL(MENU)**] key until “**Radio Setup**” menu appears.
2. Turn the **CHANNEL** selector knob to select “**DSC Setup**” menu.
3. Press the [**ENT**] key, then select “**DSC Beep**” with the **CHANNEL** selector knob.
4. Press the [**ENT**] key.
5. Turn the **CHANNEL** selector knob to select “**POS Request.**”
6. Turn the **CHANNEL** selector knob to select “**Off.**”
7. Press the [**ENT**] key to store the selected setting.
8. To exit this menu and return to radio operation mode press the [**16/9**] key.



If you wish to return to enabling the ringer tone, just repeat the above procedure, turning the **CHANNEL** selector knob to select “**On**” in step “6” above.

## 11.7.2 Transmitting a Position Request to Another Vessel

### Pre-Programmable Request

1. Press the [**CALL(MENU)**] key. The “**DSC Operation**” menu will appear in the display.
2. Turn the **CHANNEL** selector knob to select “**POS Request.**”
3. Press [**ENT**] key to show the Position request directory. This directory uses the INDIVIDUAL Directory information.
4. Turn the **CHANNEL** selector knob to select a name, then press the [**ENT**] key.
5. Press the [**ENT**] key to transmit the position request DSC call.
6. When the **GX1500S** receives the position from the polled vessel it is shown on the radio display and also transferred to the GPS Chart plotter.
7. If the **GX1500S** does not receive a reply, the display will be as shown in the illustration on the right. To send again, press the [**ENT**] key.

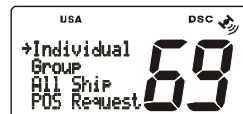

## NOTE

If the **GX1500S** does not receive position data from the polled vessel, the LCD will show “NO POSITION DATA.”

### Manual Request

You may enter an MMSI number manually to contact without the Setting up the Individual / Position Call Directory.

1. Press the [**CALL(MENU)**] key. The “**DSC Operation**” menu will appear in the display.
2. Turn the **CHANNEL** selector knob to select “**POS Request.**”
3. Press [**ENT**] key to show the Position request directory. This directory uses the INDIVIDUAL Directory information.
4. Turn the **CHANNEL** selector knob to select the “**Manual,**” then press the [**ENT**] key.
5. Turn the **CHANNEL** selector knob to scroll through numbers, 0-9. To enter the desired number and move one space to the right press the [**ENT**] key. Repeat this procedure until all nine space of the MMSI number which you want to contact are entered.
6. If a mistake was made entering in the MMSI number repeat pressing the [**H/L(NAV)**] key until the wrong number is selected, then move the channel knob to correct the entry.
7. When finished entering the MMSI number, press and hold the [**ENT**] key.
8. Press the [**ENT**] key to transmit the position request DSC call.
9. When the **GX1500S** receives the position from the polled vessel it is shown on the radio display and also transferred to the GPS Chart plotter.
10. If the **GX1500S** does not receive a reply, the display will be as shown in the illustration on the right. To send again, press the [**ENT**] key.

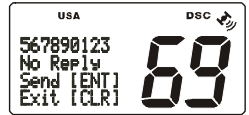

### 11.7.3 Receiving a Position Request

When a position request call is received from another vessel, a ringing alarm will sound and POS REQUEST will be shown in the LCD. Operation and transceiver function differs depending on “POS Reply” in the “DSC Setup” menu setting.

#### **Automatically reply:**

1. When a position request call is received, a calling alarm sounds 4 times. Then requested position coordinates are transmitted automatically to the vessel requesting your vessels position.
2. To exit from position request display, press any key.



#### **Manually reply:**

1. When a position request call is received from another vessel, the LCD will be as shown in the illustration at the right.
2. A ringing alarm sounds 4 times. Then select type of reply function “Send” or “No Reply” by using the CHANNEL selector knob.
3. The GX1500S display will show “Send” or “No Reply” allowing you to send your vessels location by using the CHANNEL selector knob.
4. When “Send” is selected, press the [ENT] key. And your position will be transmitted to the requesting vessel.
5. To exit from position request display, press the [16/9] key.

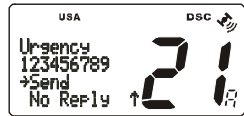

## 11.8 POSITION SEND

The feature is similar to Position Request, however instead of requesting a position of another vessel this function allows you to send your position to another vessel. Your vessel must have an operating GPS receiver connected for the **GX1500S** to send the position.

### 11.8.1 Setting up a Position Send Ringer

The **GX1500S** has the capability to turn off the Position Send ringer.

1. Press and hold down the [**CALL(MENU)**] key until “Radio Setup” menu appears.
2. Turn the **CHANNEL** selector knob to select “DSC Setup” menu.
3. Press the [**ENT**] key, then select “DSC Beep” with the **CHANNEL** selector knob.
4. Press the [**ENT**] key.
5. Turn the **CHANNEL** selector knob to select “POS Send.”
6. Turn the **CHANNEL** selector knob to select “Off.”
7. Press the [**ENT**] key to store the selected setting.
8. To exit this menu and return to radio operation mode press the [**16/9**] key.

If you wish to return to enabling the ringer tone, just repeat the above procedure, turning the **CHANNEL** selector knob to select “On” in step “6” above.



## 11.8.2 Transmitting a DSC Position Send Call

### Pre-Programmable Calling

1. Press the [**CALL(MENU)**] key. The “DSC Operation” menu will appear in the display.
2. Turn the **CHANNEL** selector knob to select the “POS Send.”
3. Press the [**ENT**] key to select the Individual directory.
4. Turn the **CHANNEL** selector knob to select a name in the directory, then press the [**ENT**] key.
5. Press the [**ENT**] key to send your position to the selected vessel.

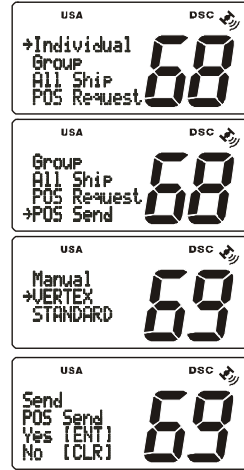

### Manual Calling

You may enter an MMSI number manually to contact without the Setting up the Individual / Position Call Directory.

1. Press the [**CALL(MENU)**] key. The “DSC Operation” menu will appear in the display.
2. Turn the **CHANNEL** selector knob to select the “POS Send.”
3. Press [**ENT**] key to show the Position Send directory. This directory uses the INDIVIDUAL Directory information.
4. Turn the **CHANNEL** selector knob to select “Manual,” then press the [**ENT**] key.
5. Enter the MMSI number (nine digits) which you want to contact, then press the [**ENT**] key.
6. Press the [**ENT**] key to send your position to the selected vessel.

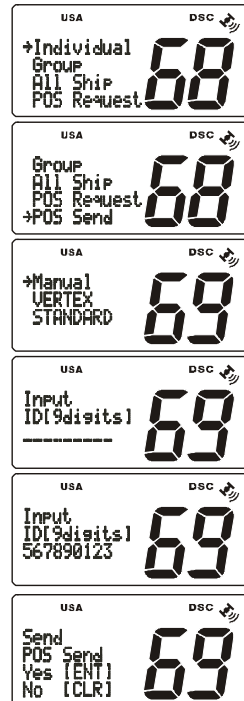

### **11.8.3 Receiving a DSC Position Send Call**

When another vessel transmits their location to the **GX1500S** the following will happen:

1. A ringing sound will be produced when the call is received.
2. Press the **[16/9]** key to stop ringing
3. The position from the calling vessel will be shown on the display of the radio and also transferred to any Standard Horizon GPS Chart plotter if connected.

## 11.9 MANUAL INPUTTING OF THE GPS LOCATION (LAT/LON)

You may send the Latitude/Longitude of your vessel manually even if the **GX1500S** is not connected the GPS receiver unit.

After the position is entered, transmitting a DSC Distress, Position Request, or Position Send will contain the manually entered position.

1. Press and hold down the [**CALL(MENU)**] key until “**Radio Setup**” menu appears.
2. Turn the **CHANNEL** selector knob to select “**DSC Setup**” menu.
3. Press the [**ENT**] key, then select “**POS Input**” with the **CHANNEL** selector knob.
4. Press the [**ENT**] key. The transceiver will beep, and the display will be as shown in the illustration on the right.
5. Enter the your local time by the 24-hour system on the UTC time. Use the [**ENT**] and [**H/L(NAV)**] key to navigate to each column of the time, then use the **CHANNEL** selector knob to select the desired numbers in each colum. Repeat for each column, to complete the time.
6. Enter the Latitude/Longitude of your vessel location with the same procedure as description above.
7. To store the data entered, press the [**ENT**] key. To exit this menu and return to radio mode press the [**16/9**] key.

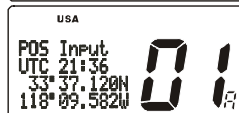
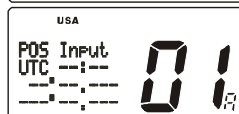
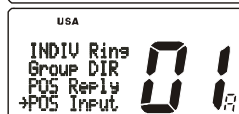





## 12 RADIO SETUP

### NOTE

The optional **CMP25** RAM+ mic and **VH-310** Handset can also change the RADIO SETUP menu. Refer to page 68 (RAM+ mic) and page 76 (**VH-310**) for details.

### 12.1 LAMP ADJUSTING

Allows setting up the backlight intensity or to turn it off.

1. Press and hold down the [**CALL(MENU)**] key until “**Radio Setup**” menu appears.
2. Press the [**ENT**] key, then select “**Dimmer**” in the “**Radio Setup**” menu with the **CHANNEL** selector knob.
3. Press the [**ENT**] key.
4. Turn the **CHANNEL** selector knob to select the desired level. When “**OFF**” is selected, the lamp is extinguished.
5. Press the [**ENT**] key to store the selected level.
6. To exit this menu and return to radio operation mode press the [**16/9**] key.

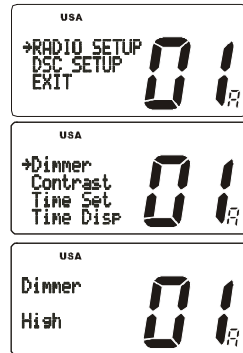

### 12.2 LCD CONTRAST

This selection sets up the display for best viewability for the varying mounting locations (overhead or below).

1. Press and hold down the [**CALL(MENU)**] key until “**Radio Setup**” menu appears.
2. Press the [**ENT**] key, then select “**Contrast**” in the “**Radio Setup**” menu with the **CHANNEL** selector knob.
3. Press the [**ENT**] key.
4. Turn the **CHANNEL** selector knob to select the desired level. The contrast level can be set from “**00**” to “**31**.”
5. Press the [**ENT**] key to store the selected level.
6. To exit this menu and return to radio operation mode press the [**16/9**] key.



## 12.3 TIME OFFSET

This selection sets the time offset between local time and UTC (time GPS sends to radio). Time is displayed when GPS position (LAT/LON) is displayed by pressing the [F] key followed by the [6(NAV)] key.

1. Press and hold down the [CALL(MENU)] key until "Radio Setup" menu appears.
2. Press the [ENT] key, then select "Time Set" in the "Radio Setup" menu with the CHANNEL selector knob.
3. Press the [ENT] key.
4. Turn the CHANNEL selector knob to select time offset from UTC. See illustration below to find your offset time from UTC. If "0:00" is assigned, the time is the same as UTC (Universal Time Coordinated or GMT Greenwich Mean Time).
5. Press the [ENT] key to store the time offset.
6. To exit this menu and return to radio operation mode press the [16/9] key.

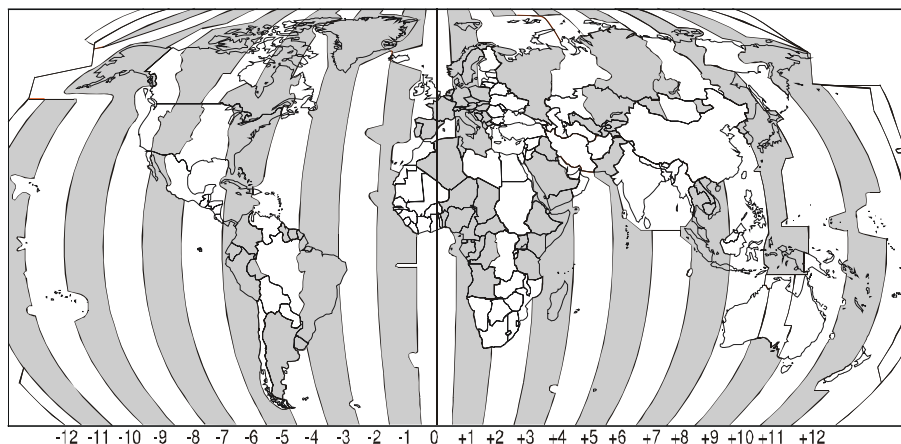
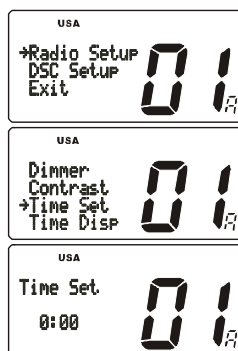

**OFFSET TIME TABLE**

## 12.4 TIME LOCATION

This selection selects the time display between local time and UTC (time GPS sends to radio). Time is displayed when GPS position (LAT/LON) is displayed by pressing the [F] key followed by the [6(NAV)] key.

1. Press and hold down the [CALL(MENU)] key until “Radio Setup” menu appears.
2. Press the [ENT] key, then select “Time Disp.” in the “Radio Setup” menu with the CHANNEL selector knob.
3. Press the [ENT] key.
4. Turn the CHANNEL selector knob to select “UTC” or “Local.”
5. Press the [ENT] key to store the selected setting.
6. To exit this menu and return to radio operation mode press the [16/9] key.

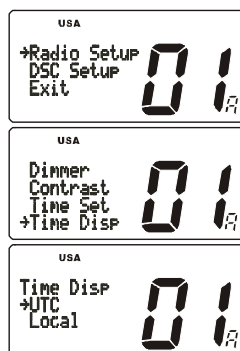

In the local time mode, the display shows the time by the 12-hour system. Meanwhile, the display shows the time by the 24-hour system in the UTC mode.

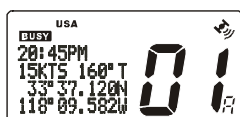

(“UTC” mode)

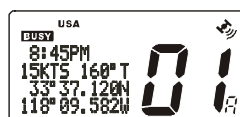

(“LOCAL” mode)

## 12.5 TRUE MAGNETIC CHANGE (NAV display)

This selection allows customizing the GPS COG (Course Over Ground) displayed on the LCD to be in True or Magnetic.

1. Press and hold down the [CALL(MENU)] key until “Radio Setup” menu appears.
2. Press the [ENT] key, then select “Magnetic” in the “Radio Setup” menu with the CHANNEL selector knob.
3. Press the [ENT] key.
4. Turn the CHANNEL selector knob to select “On” (representing “Magnetic”) or “Off” (representing “True”).
5. Press the [ENT] key to store the selected setting.
6. To exit this menu and return to radio operation mode press the [16/9] key.

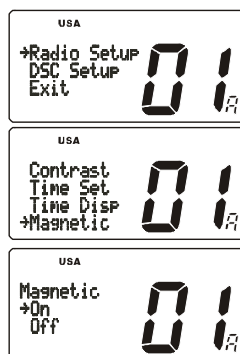

## 12.6 PRIORITY CHANNEL SET

Allows selection of the priority channel.

1. Press and hold down the [CALL(MENU)] key until “Radio Setup” menu appears.
2. Press the [ENT] key, then select “Priority CH” in the “Radio Setup” menu with the CHANNEL selector knob.
3. Press the [ENT] key.
4. Turn the CHANNEL selector knob to select the channel to be a priority.
5. Press the [ENT] key to store the selected setting.
6. To exit this menu and return to radio operation mode press the [16/9] key.

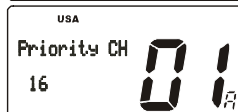

## 12.7 SCAN TYPE

This selection selects the scan mode between “Memory Scan” and “Priority Scan.”

1. Press and hold down the [CALL(MENU)] key until “Radio Setup” menu appears.
2. Press the [ENT] key, then select “SCAN Type” in the “Radio Setup” menu with the CHANNEL selector knob.
3. Press the [ENT] key.
4. Turn the CHANNEL selector knob to select “Priority” or “Memory.”
5. Press the [ENT] key to store the selected setting.
6. To exit this menu and return to radio operation mode press the [16/9] key.

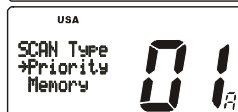

## 12.8 SCAN RESUME TIME

This selection is used to select the time the **GX1500S** waits after a transmission ends before starting scanning.

1. Press and hold down the [CALL(MENU)] key until “Radio Setup” menu appears.
2. Press the [ENT] key, then select “SCAN Resume” in the “Radio Setup” menu with the CHANNEL selector knob.
3. Press the [ENT] key.
4. Turn the CHANNEL selector knob to select the desired resume time. The resume time can be set to “1sec,” “2sec,” “3sec,” or “Off.” In the “Off” selection, the scanner will resume after the other station stops transmitting (carrier drops).
5. Press the [ENT] key to store the selected setting.
6. To exit this menu and return to radio operation mode press the [16/9] key.



## 12.9 KEY BEEP (ON/OFF)

This selection allows the beep tone when a key is pressed to be turned off.

1. Press and hold down the [CALL(MENU)] key until “Radio Setup” menu appears.
2. Press the [ENT] key, then select “Key Beep” in the “Radio Setup” menu with the CHANNEL selector knob.
3. Press the [ENT] key.
4. Turn the CHANNEL selector knob to select “On” or “Off.”
5. Press the [ENT] key to set the key beep condition.
6. To exit this menu and return to radio operation mode press the [16/9] key.



### NOTE

Emergency alarm and beeps for DSC operation cannot be turned OFF.

## 12.10 WX ALERT

This selection allows the radios NOAA Weather alert to be turned off. Default setting is ON.

1. Press and hold down the [CALL(MENU)] key until “Radio Setup” menu appears.
2. Press the [ENT] key, then select “WX Alert” in the “Radio Setup” menu with the CHANNEL selector knob.
3. Press the [ENT] key.
4. Turn the CHANNEL selector knob to select the desired WX alert mode. The WX alert mode can be set to “On WX,” “On SCAN,” “On SCAN/WX,” or “Off.”
5. Press the [ENT] key to store the selected setting.
6. To exit this menu and return to radio operation mode press the [16/9] key.

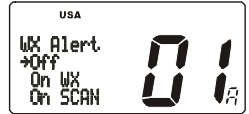
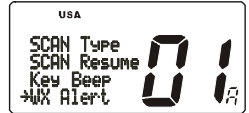

## 12.11 CHANNEL NAME CHANGE

This selection allows you to customize the name of a channel from the default name.

1. Press and hold down the [CALL(MENU)] key until “Radio Setup” menu appears.
2. Press the [ENT] key, then select “CH Name” in the “Radio Setup” menu with the CHANNEL selector knob.
3. Press the [ENT] key.
4. Turn the CHANNEL selector knob to select the channel to be named, then press the [ENT] key.
5. Turn the CHANNEL selector knob to scroll through the first letter of the channel name.
6. Press the [ENT] key to store the first letter in the name and step to the next letter to the right.
7. Repeat step 6 and 7 until the name is complete. The name can consist of up to twelve characters, if you do not use all twelve characters press the [ENT] key to move to the next space. This method can also be used to enter a blank space in the name. To clear the previous letter, press the [CLR] key.
8. Press and hold the [ENT] key to enter the name and exit from the “CH Name” menu. The LCD will return to the “Radio Setup” menu.
9. If you want to enter the name of another channel, select “Next” then press the [ENT] key. Otherwise, select “Exit” then press the [ENT] key.
10. To exit this menu and return to radio operation mode press the [16/9] key.

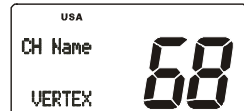
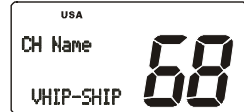
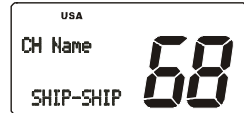
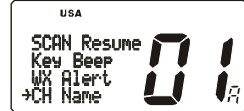



## 12.12 NAMING THE RADIO OR SECOND STATION MIC OR HANDSET

This selection allows you to provide the name to the radio and optional RAM+ Mic's when connected.

1. Press and hold down the [CALL(MENU)] key until "Radio Setup" menu appears.
2. Press the [ENT] key, then select "Unit Name" in the "Radio Setup" menu with the CHANNEL selector knob.
3. Press the [ENT] key.
4. Turn the CHANNEL selector knob to select the Unit ("Radio" or "RAM1") to be named, then press the [ENT] key.
5. Turn the CHANNEL selector knob to scroll through the first letter of the channel name.
6. Press the [ENT] key to store the first letter in the name and step to the next letter to the right.
7. Repeat step 6 and 7 until the name is complete. The name can consist of up to twelve characters, if you do not use all twelve characters press the [ENT] key to move to the next space. This method can also be used to enter a blank space in the name. To clear the previous letter, press the [CLR] key.
8. Press and hold the [ENT] key to enter the name and return to the "Unit Name" menu.
9. If you want to enter the name of another unit, repeat steps 4 through 8.
10. To exit this menu and return to radio operation mode press the [16/9] key.

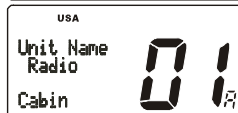
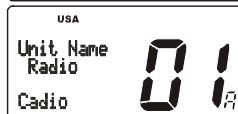
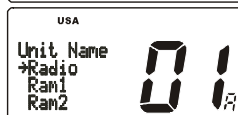

## 13 ENHANCED RAM+ MIC OPERATION

When the RAM+ microphone is connected to the **GX1500S**, most VHF, DSC, and setup menus can be remotely operated. The RAM+ Mic is supplied with 23 feet (7 m) of routing cable and can be extended up to 70 feet (21 m) using three 23 feet extension cables model **CT-100**. The intercom operation can be used between the RAM+ Mic and the transceiver.

### 13.1 RAM+ MIC CONTROLS

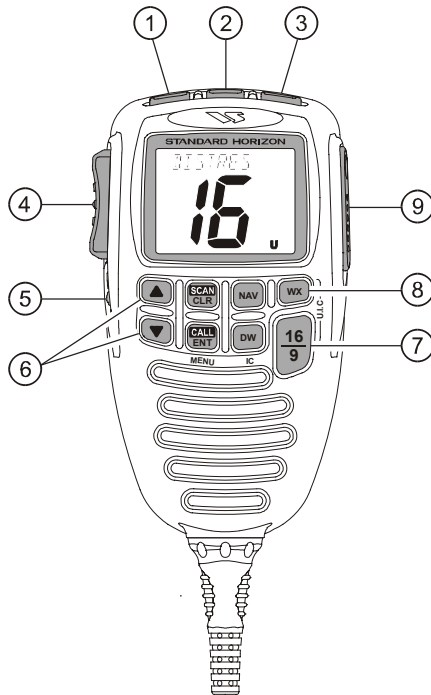

#### ① SQUELCH CONTROL (SQL)

Activates the squelch adjusting mode.

Press this key to activate the squelch adjusting mode. Press the microphone's [▲] or [▼] key to adjust the squelch.

When this key is pressed and held down for 1 second or more, the squelch is turned off.

#### ② VOLUME KEY (VOL)

Activates the volume adjusting mode.

Press this key to activate the volume adjusting mode. Press the microphone's [▲] or [▼] to adjust the volume.

③ **POWER SWITCH (PWR)**

Press and hold down this key to turn to the transceiver and RAM+ Mic on and off.

④ **PTT (Push-To-Talk) SWITCH**

Activates transmission.

⑤ **[H/L] KEY**

Toggles between high and low power. When the [H/L] key is pressed while the transceiver is on channel 13 or 67, the power will temporarily switch from LO to HI power until the **PTT** is released. The [H/L] key does not function on transmit inhibited and low power only channels.

⑥ **[▲](UP)/[▼](DOWN) KEY**

These keys are used to select channels, adjust the volume and squelch level, and to choose the item selection of different functions (such as the DSC operation). In many ways, these keys emulate the function of the transceiver's **CHANNEL** selector knob.

⑦ **[16/9] KEY**

Immediately recalls channel 16 from any channel location. Holding down this key recalls channel 9. Pressing the [16/9] key reverts to the previous selected working channel.

**Secondary use**

Please see secondary use for the [WX] and [MEM] key.

⑧ **KEY PAD**

**[SCAN] Key**

1. Starts and stops scanning of programmed channels.
2. If held while the [UP(▲)] or [DOWN(▼)] key on the microphone are pressed, the radio will show the channels programmed in scan memory. This function will not work if the unit is scanning.

**NOTE:** The priority channel by default is Channel 16, however the priority channel can be changed. To select a different priority channel refer to section “12.7 SCAN TYPE.”

**[CALL/SET] Key**

The [CALL/SET] key functions as the enter key.

**Secondary use**

Press the [CALL/SET] key to access the DSC OPERATION menu.

Press and hold the [CALL/SET] key to access the SETUP menu.

### [DW] Key

Watches for a transmission on CH16 and another selected channel until either signal is received. (Dual watch)

#### **Secondary use**

Press and hold [DW] key, intercom operation will operate between radio and RAM+ Mic.

### [NAV] Key

Press this key, when connected to the GPS receiver, the LCD displays Position Data and Time from the GPS.

### [WX] Key

Immediately recalls the previously selected US NOAA weather channel from any channel location.

#### **Secondary use**

Holding down the [16/9] key while pressing the [WX] key switch the Channel Group.

**NOTE:** If position is displayed, this icon will be hidden.

### ⑨ [DISTRESS] KEY

Used to send a DSC Distress Call. To send the distress call refer to section “11.3.1. Transmitting a DSC Distress Call.”

## 13.2 INTERCOM OPERATION

### 13.2.1 Communication

1. Press and hold the [DW] key while in the “RADIO” mode, the mode is changed to “INTERCOM” mode. When the “INTERCOM” operation is activated, “IC” is displayed on the RAM+ Mic (and **VH-310** Handset) and “INTERCOM” is displayed on the **GX1500S**.



2. Press the **PTT** switch, “TALK” is displayed.

**NOTE:** A warning beep is emitted when the RAM+ Mic **PTT** switch is pressed while the transceiver microphone’s **PTT** switch is pressed.



(RAM+ Mic's **PTT** switch is pressed)

3. Speak slowly and clearly into the microphone, hold the microphone about 1/2 inch away from your mouth.
4. When finished, release the **PTT** switch.
5. Press the [DW] key momentarily the mode will revert to “RADIO” mode.

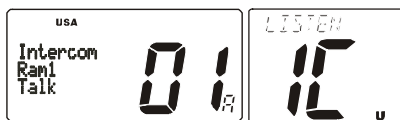

(**GX1500S**'s **PTT** switch is pressed)

### 13.2.2 Calling

Hold down the [DW] key for 1 second or more, when the “INTERCOM” operation is activated. A calling beep is emitted twice from the transceiver speaker.

### 13.3 DSC/RADIO SETUP MODE

The RAM+ can access the DSC / RADIO setup menu (refer to section “11 DIGITAL SELECTIVE CALLING” and section “12 RADIO SETUP MODE” for details). The **LAMP**, **CONTRAST**, and **KEY BEEP** menu item accessed from the RAM+ only controls the RAM+’s display and speaker.

DSC/RADIO Setup mode from the RAM+:

1. Press and hold down the [CALL/SET] key until “RADIO SETUP” menu appears.
2. Press the [▲]/[▼] key to select “RADIO SETUP” or “DSC SETUP” menu.
3. Press the [CALL/SET] key, then select the menu item you wish to work on by pressing the [▲]/[▼] key.
4. Press the [CALL/SET] key.
5. Press the [▲]/[▼] key to change the value or condition for the menu item, then press the [CALL/SET] key to save the new setting.
6. Press the [▲]/[▼] key to select “EXIT,” then press the [CALL/SET] key to return to the normal operation.

**RADIO SETUP-menu**

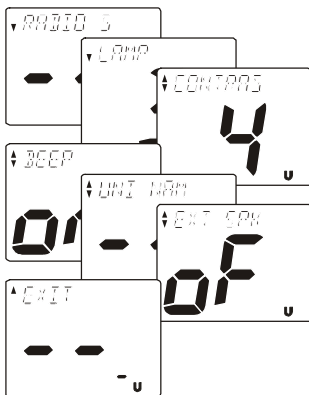

**DSC SETUP-menu**

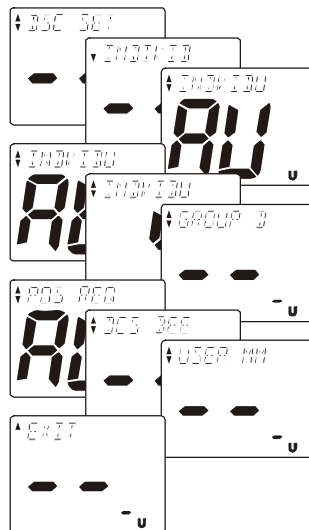

#### NOTE

When setup menu is selected, the **GX1500S** will be temporarily disabled until the RAM+ mic, exits from the setup mode.

**MEMO**

-----

-----

-----

-----

-----

-----

-----

-----

-----

-----

-----

-----

-----

-----

-----

-----

-----

-----

-----

-----

-----

-----

-----

-----

-----

-----

## 14 VH-310 HANDSET OPERATION

When the **VH-310** HANDSET is connected to the **GX1500S**, most VHF, DSC, and setup menus can be remotely operated. The **VH-310** HANDSET is supplied with 23 feet (7 m) of routing cable and can be extended up to 70 feet (21 m) using three 23 feet extension cables model **CT-100**. The intercom operation can be used between the **VH-310** HANDSET or the **GX1500S**.

### 14.1 VH-310 HANDSET CONTROLS

- ① **PWR** key  
Press and hold down this key to turn to the transceiver and **VH-310** HANDSET on and off.
- ② **PTT (Push-To-Talk)** Switch  
Activates transmission.
- ③ **[H/L]** key  
Toggles between high and low power. When the **[H/L]** key is pressed while the transceiver is on channel 13 or 67, the power will temporarily switch from “LO” to “HI” power until the **PTT** is released. The **[H/L]** key does not function on transmit inhibited and low power only channels.
- ④ **[DISTRESS]** key  
Used to send a DSC Distress Call. To send the distress call refer to section “**11.3.1. Transmitting a DSC Distress Call.**”
- ⑤ **RADIO CONTROL KEYS**  
**[VOL]** key  
Activates the volume adjusting mode.  
Press this key to activate the volume adjusting mode.  
Press the **[▲]** or **[▼]** to adjust the volume.

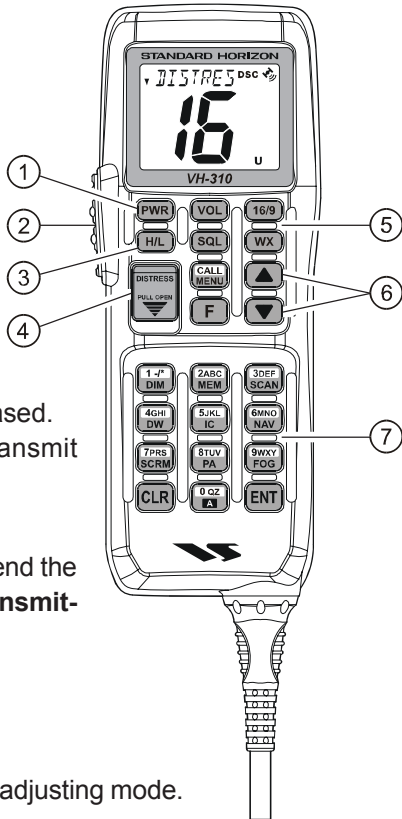

#### NOTE

When the **VH-310** handset is removed from the cradle the speaker audio will be automatically reduced so not to damage your hearing. When the **VH-310** is in the cradle the speaker audio will increase so communications can be heard.



### [SQL] key

Activates the squelch adjusting mode.

Press this key to activate the squelch adjusting mode. Press the [▲] or [▼] key to adjust the squelch.

### [CALL(MENU)] key

The [CALL(MENU)] key functions as the enter key.

#### **Secondary use**

Press the [CALL(MENU)] key to access the DSC OPERATION menu. The "INDIVIDUAL CALL," "GROUP CALL," "ALL SHIP CALL," "POSITION REQUEST," "POSITION SEND," "STANDBY MODE," and "CALL WAITING" functions can be accessed from the DSC OPERATION menu. Press and hold the [CALL(MENU)] key to access the RADIO SETUP (refer to section 12) or DSC SETUP menu (refer to section 11).

### [F] key

Activates the "Alternate" key function.

Press this key to activates the "Alternate" key function of the ten keypad.

### [16/9] key

Immediately recalls channel 16 from any channel location. Holding down this key recalls channel 9. Pressing the [16/9] key reverts to the previous selected working channel.

#### **Secondary use**

Press and hold the [16/9] key then press the [WX] key to switch the USA, International or Canadian channels.

### [WX] key

Immediately recalls the previously selected US NOAA weather channel from any channel location.

#### **Secondary use**

Holding down the [16/9] key while pressing the [WX] key switches the Channel Group.

### ⑥ [▲] / [▼] KEY

These keys are used to select channels, adjust the volume and squelch level, and to choose the item selection of different functions (such as DSC operation).

## ⑦ **KEYPAD**

### **[1(DIM)]** key

When in radio mode, this key is used to directly select channel digit “1” in a channel number.

#### **Secondary use**

Press the **[F]** key first then press the **[1(DIM)]** key to access the LCD Dimmer menu. Refer to section “**12.1 LAMP ADJUSTING**” for details.

### **[2(MEM)]** Key

When in radio mode, this key is used to directly select channel digit “2” in a channel number.

#### **Secondary use**

Press the **[F]** key first then press the **[2(MEM)]** key, memorize the selected channel into the transceiver scan memory for scanning. When repeat the same procedures (**[F]** → **[2(MEM)]**), will delete the channel from the scan memory. Refer to section “**10.12 SCANNING**” for details.

### **[3(SCAN)]** Key

When in radio mode, this key is used to directly select channel digit “3” in a channel number.

#### **Secondary use**

Press the **[F]** key first then press the **[3(SCAN)]** key to start and stop the scanning of programmed channels. Refer to section “**10.12 SCANNING**” for details.

### **[4(DW)]** Key

When in radio mode, this key is used to directly select channel digit “4” in a channel number.

#### **Secondary use**

Press the **[F]** key first then press the **[4(DW)]** key to scan for voice communications on the priority channel and another selected channel until a signal is received on either channel (Dual Watch). Refer to section “**10.11 DUAL WATCH (TO PRIORITY CHANNEL)**” for details.

### **[5(IC)]** Key

When in radio mode, this key is used to directly select channel digit “5” in a channel number.

#### **Secondary use**

Press the **[F]** key then press the **[5(IC)]** key to activate intercom function between RAM+(s) or **VH-310** handset(s).

Refer to section “**14.2 INTERCOM OPERATION**” for details.

### [6(NAV)] Key

When in radio mode, this key is used to directly select channel digit “6” in a channel number.

#### **Secondary use**

Press the [F] key first then press the [6(NAV)] key, the LCD will display NAV GPS Data, Time, SOG (Speed Over Ground), and COG (Course Over Ground) when a GPS is connected to the accessory cable of the **GX1500S**. See section “**8.4 CONNECTION OF GPS WITH NMEA OUTPUT**” for details.

### [7(SCRM)] Key

When in radio mode, this key is used to directly select channel digit “7” in a channel number.

### [8(PA)] Key

When in radio mode, this key is used to directly select channel digit “8” in a channel number.

### [9(FOG)] Key

When in radio mode, this key is used to directly select channel digit “9” in a channel number.

### [0] Key

When in radio mode, this key is used to directly select channel digit “0” in a channel number.

#### **Secondary use**

Used to select A (alpha channels). Press the desired channel keys then press and hold [0] key until “A” appears next to the channel number and press [ENT] to select the channel.

### [CLR] Key

Press the [CLR] key to cancel the menu selection and/or keypad entry.

### [ENT] Key

Press the [ENT] key to enter the menu selection and/or keypad entry.

## 14.2 INTERCOM OPERATION

### 14.2.1 Communication

1. Press the [F] key followed by the [5(IC)] key, the mode is changed to “INTERCOM” mode.
2. When the “INTERCOM” operation is activated, “IC” is displayed on the **VH-310** Handset (and RAM+ Mic, if used) and “INTERCOM” is displayed on the **GX1500S**.
3. Press the **PTT** switch, “TALK” is displayed.

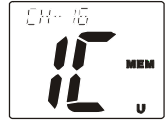

**NOTE:** A warning beep is emitted when the RAM+ Mic **PTT** switch is pressed while the transceiver microphone's **PTT** switch is pressed.

4. Speak slowly and clearly into the microphone, hold the microphone about 1/2 inch away from your mouth.
5. When finished, release the **PTT** switch.
6. To exit the “INTERCOM” mode and return to radio operation mode, press the [F] key followed by the [5(IC)] key again.



(VH-310's PTT switch is pressed)

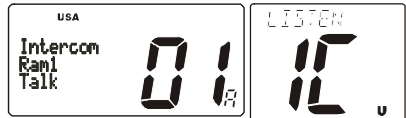

(GX1500S's PTT switch is pressed)

### 14.2.2 Calling

Press and hold the [5(IC)] key for 1 second when the “INTERCOM” operation is activated, a calling beep is emitted from the **GX1500S** speaker.

## 14.3 MANUAL INPUTTING OF THE GPS LOCATION (LAT/LON)

You may send the Latitude/Longitude of your vessel manually from the **VH-310** Handset even if the **GX1500S** is not connected the GPS receiver unit.

After the position is entered, transmitting a DSC Distress, Position Request, or Position Send will contain the manually entered position.

1. Press and hold down the [**CALL(MENU)**] key until “Radio Setup” menu appears.
2. Press the [**▼**] key to select “DSC SETUP” menu.
3. Press the [**ENT**] key, then select “POS INPUT” with the [**▲**]/[**▼**] key.
4. Press the [**ENT**] key then, enter the your local time from the keypad by the 24-hour system on the UTC time.
5. Enter the Latitude of your vessel location (xx.xx.xx) by the keypad, then press the [**6(NAV)**] key to select North (N), or [**7(SCRM)**] key to select South (S).
6. Enter the Longitude of your vessel location (xxx.xx.xx) by the keypad, then press the [**3(SCAN)**] to select East (E), or [**9(FOG)**] key to select West (W).
7. If a number was entered by mistake, press the **H/L** key repeatedly to select the number. Press the [**▲**]/[**▼**] key to select the desired number.
8. Press and hold in the [**ENT**] key to store the data entered, then press the [**16/9**] key to exit this menu and return to radio operation mode.

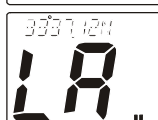
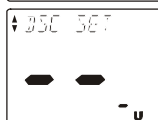
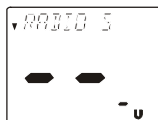

## 14.4 DSC/RADIO SETUP MODE

The **VH-310** Handset can access the DSC / RADIO setup menu (refer to section “**11 DIGITAL SELECTIVE CALLING**” and section “**12 RADIO SETUP MODE**” for details). The **CONTRAST**, **NAV DISPLAY**, **KEY BEEP**, and **AF SELECT** menu item accessed from the **VH-310** Handset only controls the **VH-310** Handset’s display and speaker.

DSC/RADIO Setup mode from the **VH-310** Handset:

1. Press and hold down the [**CALL(MENU)**] key until “**RADIO SETUP**” menu appears.
2. Press the [**▲**]/[**▼**] key to select “**RADIO SETUP**” or “**DSC SETUP**” menu.
3. Press the [**ENT**] key, then select the menu item you wish to work on by pressing the [**▲**]/[**▼**] key.
4. Press the [**ENT**] key.
5. Press the [**▲**]/[**▼**] key to change the value or condition for the menu item, then press the [**ENT**] key to save the new setting.
6. Press the [**▲**]/[**▼**] key to select “**EXIT**,” then press the [**ENT**] key to return to the normal operation.

**RADIO SETUP-menu**

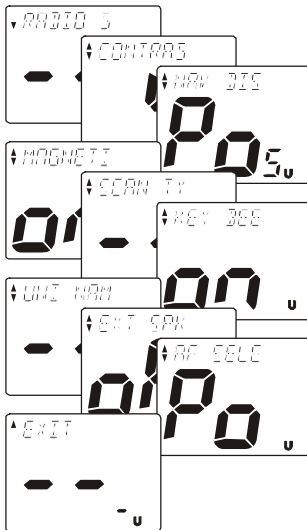

**DSC SETUP-menu**

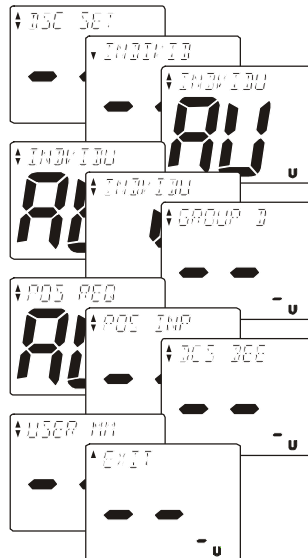

### NOTE

When the SETUP menu is selected, using the **VH-310** Handset, the **GX1500S** will be temporarily disabled until the **VH-310** Handset exits from the setup mode.

### 14.4.1 Changing GPS Information to Vessel position or COG

Allows customizing the NAV data showing GPS Information. Factory default is “Your Vessel’s Current Position,” however, following the steps below the GPS Information can be changed to “Course Over Ground (COG).”

1. Press and hold down the [CALL(MENU)] key until “**RADIO SETUP**” menu appears.
2. Press the [ENT] key, then select “**NAV DISPLAY**” with the [▲]/[▼] key.
3. Press the [CALL(SET)MENU] key.
4. Press the [▼] or [▲] key to select “**Pos** (Your Vessel’s Current Position)” or “**Cru** (Course Over Ground).”
5. Press the [ENT] key to store the data entered, then press the [16/9] key to exit this menu and return to radio operation mode.

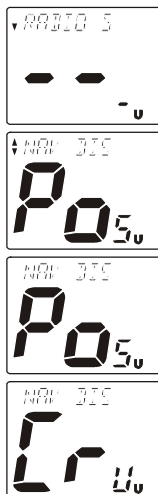

### 14.4.2 External Speaker AF Selection

The **AF SELECT** menu allows you to set the audio output level of the **VH-310**'s External Speaker to “fixed” regardless the VOL level setting of the **VH-310**, which is useful to the case when use with the amplified speaker, such as the Standard Horizon **MLS-310**.

1. Press and hold down the [CALL(MENU)] key until “**Radio Setup**” menu appears.
2. Press the [ENT] key, then select “**AF SELECT**” with the [▲]/[▼] key.
3. Press the [ENT] key.
4. Press the [▲] or [▼] key to select “**Pr**” (External Speaker Level is “Fixed”) or “**Po**” (External Speaker Level is “Adjustable”).
5. Press the [ENT] key to store the data entered, then press the [16/9] key to exit this menu and return to radio operation mode.

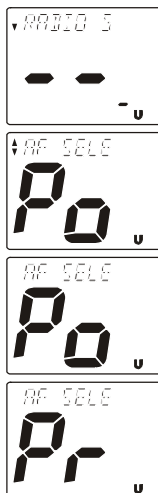

## 15 MAINTENANCE

The inherent quality of the solid-state components used in this transceiver will provide many years of continuous use. Taking the following precautions will prevent damage to the transceiver.

- Keep the microphone connected or the jack covered at all times to prevent corrosion of electrical contacts;
- Never key the microphone unless an antenna or suitable dummy load is connected to the transceiver.
- Ensure that the supply voltage to the transceiver does not exceed 16 VDC or fall below 11 VDC.
- Use only STANDARD HORIZON-approved accessories and replacement parts.

In the unlikely event of serious problems, please contact your Dealer or our repair facility. Address and phone numbers for this facility, as well as warranty information, are contained in section “**17 WARRANTY.**”

### 15.1 REPLACEMENT PARTS

Occasionally an owner needs a replacement mounting bracket or knob. These can be ordered from our Parts Department by writing or calling:

**Marine Division of Vertex Standard**

US Headquarters

10900 Walker Street, Cypress, CA 90630, U.S.A.

Telephone (714) 827-7600

Commonly requested parts, and their part numbers are listed below.

- **Panel Cover:** RA0777900
- **Power Cord:** T9023306
- **VOL/SQL Knob (Black):** RA0757600
- **VOL/SQL Knob (White):** RA0763500
- **Rotary Channel Knob (Black):** RA0757700
- **Rotary Channel Knob (White):** RA0763600
- **Mounting Bracket (Black):** RA0784000
- **Mounting Bracket (White):** RA0784100
- **Mounting Bracket Knob (Black):** RA045910A
- **Mounting Bracket Knob (White):** RA043770A
- **Microphone Hanger (Black):** RA0458800
- **Microphone Hanger (White):** RA0436000
- **RAM+ Mic or VH-310 Routing Cable Assembly:** S8101512



## 15.2 FACTORY SERVICE

In the unlikely event that the radio fails to perform or needs servicing, please contact the following:

### Standard Horizon

#### Attention Marine Repair Department

10900 Walker Street, Cypress, CA 90630

Telephone (800) 366-4566

An “RA” Return Authorization number is not necessary to send a product in for service. Include a brief note describing the problem along with your name, return address, phone number, and proof of purchase.

## 15.3 TROUBLESHOOTING CHART

SYMPTOM	PROBABLE CAUSE	REMEDY
Transceiver fails to power up.	No DC voltage to the transceiver, or blown fuse.	a. Check the 12VDC battery connections and the fuse. b. The <b>PWR</b> key needs to be pressed and held to turn the radio on.
Transceiver blows fuse when connected to power supply.	Reversed power wires.	Check the power cable for DC voltage, or replace the fuse (6A 250V). Make sure the red wire is connected to the positive (+) battery post, and the black wire is connected to the negative (-) battery post. If the fuse still blows, contact your Dealer.
Popping or whining noise from the speaker while engine runs.	Engine noise.	Reroute the DC power cables away from the engine. Add noise suppressor on power cable. Change to resistive spark plug wires and/or add an alternator whine filter.
Sound is not emitted from the internal or external speaker.	Accessory cable.	Check the connections of the accessory cable (Possible short circuit on the External speaker cable WHITE/SHIELD).
Receiving station report low transmit power, even with transceiver set to HI power.	Antenna.	Have the antenna checked or test the transceiver with another antenna. If the problem persists, contact your Dealer for servicing.
“HI BATTERY” or “LO BATTERY” message is appeared when the power is turned on.	The power supply voltage is too high or too low.	Confirm that the connected power supply voltage is not 17 volts or lower than 10 volts. Confirm that the generator has not malfunctioned.
Your position is not displayed.	Accessory cable.	Check the accessory cable connection. Some GPS use the battery ground line for NMEA connection.
	Setting of the GPS navigation receiver.	Check the output signal format of the GPS navigation receiver. This radio requires NMEA0183 format with GLL, RMB, GGA, or GNS sentence as an output signal. If the GPS has a baud rate setting make sure to select 4800 and parity to NONE.

## 16 CHANNEL ASSIGNMENTS

Tables on the following columns list the VHF Marine Channel assignments for U.S.A. and International use. Below are listed some data about the charts.

1. VTS. Where indicated, these channels are part of the U.S. Coast Guard's **Vessel Traffic System**.
2. Alpha channel numbers, that is, channel numbers followed by the letter A (such as Channel 07**A**) are **simplex** channels on the U.S.A. or Canadian channel assignments whose counterparts in the International assignments are **duplex** channels. International channels do not use "alpha" numbers. If you call the Coast Guard on Channel 16, they will sometimes ask you to "**go to channel 22 Alpha**." This is a channel assigned to U.S.A. and Canadian Coast Guards for handling distress and other calls. If your radio is set for **International** operation you will go to Channel 22 instead of 22**A**, and will not be able to communicate with the Coast Guard. To use Channel 22**A**, your radio must be set for **USA** or **Canada** operation, usually by a U/I/C (USA/International/Canada) control or combination of controls. Channel 22 (without an "A") is an **International** duplex channel for port operations. Some radios indicate an "A" adjacent to the alpha channels on the display; on others "alpha" is not indicated but the proper channel is selected based on the U/I/C setting.
3. Bridge-to-Bridge channels (for example, Channel 13) are for use by bridge operators on intercoastal waterways and rivers. It is also used by marine vessels in the vicinity of these bridges for navigation and for communicating with the bridge operators. Note that a limit of 1 Watt is specified for these channels. See page 28 for additional information.
4. The **S/D** column on the chart indicates either S (simplex) or D (duplex). **Simplex** means transmitting and receiving on the same frequency. Only one party at a time can talk, unlike a telephone. Be sure to say "**over**" and release your microphone push-to-talk switch at the end of each transmission. **Duplex** operation involves the use of one frequency for transmitting and a separate frequency for receiving. On channels specified as duplex on the charts, correct mode of operation is established automatically by your radio when you select a channel; you cannot change the mode. And you still must release the push-to-talk switch after each transmission in order to listen to the radio.
5. Channels normally used by recreational boaters are those that include the term "non-commercial" in the **Channel Use** column of the chart. Some of these are shared with other users and some are used only in certain geographic regions.

**6. Marine vessels equipped with VHF radios are required to monitor Channel 16.**

VHF MARINE CHANNEL CHART								
CH	U	C	I	S/D	TX	RX	CHANNEL USE	
01		X	X	D	156.050	160.650	Public Correspondence (Marine Operator)	
01A	X			S	156.050		Port Operation and Commercial. VTS in selected areas	
02		X	X	D	156.100	160.700	Public Correspondence (Marine Operator)	
03		X	X	D	156.150	160.750	Public Correspondence (Marine Operator)	
04			X	D	156.200	160.800	Public Correspondence (Marine Operator), Port operation, ship movement	
04A		X		S	156.200		Pacific coast: Coast Guard, East Coast: Commercial fishing	
05			X	D	156.250	160.850	Public Correspondence (Marine Operator), Port operation, ship movement	
05A	X	X		S	156.250		Port operation. VTS in Seattle	
06	X	X	X	S	156.300		Inter-ship Safety	
07			X	D	156.350	160.950	Public Correspondence (Marine Operator), Port operation, ship movement	
07A	X	X		S	156.350		Commercial	
08	X	X	X	S	156.400		Commercial (Inter-ship only)	
09	X	X	X	S	156.450		Boater Calling channel, Commercial & Non-commercial (Recreational)	
10	X	X	X	S	156.500		Commercial	
11	X	X	X	S	156.550		Commercial. VTS in selected areas.	
12	X	X	X	S	156.600		Port operation. VTS in selected areas.	
13	X	X	X	S	156.650		Inter-ship Navigation Safety (Bridge-to-bridge)	
14	X	X	X	S	156.700		Port operation. VTS in selected areas.	
15	X			S	---	156.750	Environmental (Receive only)	
15		X	X	S	156.750		Commercial, non-commercial, ship movement (1 W)	
16	X	X	X	S	156.800		International Distress, Safety and Calling	
17	X	X	X	S	156.850		State Controlled (1 W)	
18			X	D	156.900	161.500	Port operation, ship movement	
18A	X	X		S	156.900		Commercial	
19			X	D	156.950	161.550	Port operation, ship movement	
19A	X			S	156.950		US: Commercial	
19A		X		S	156.950		Coast Guard	
20	X	X	X	D	157.000	161.600	Canadian Coast Guard Only, International: port operations and shipment	
20A	X			S	157.000		Port operation	
21			X	D	157.050	161.650	Port operation, ship movement	
21A	X	X		S	157.050		<b>U.S. Government Only, Canadian Coast Guard</b>	
22			X	D	157.100	161.700	Port operation, ship movement	
22A	X	X		S	157.100		US and Canadian Coast Guard Liaison and Maritime Safety Information Broadcasts announced on channel 16	
23		X	X	D	157.150	161.750	Public Correspondence (Marine Operator)	
23A	X			S	157.150		<b>U.S. Government Only</b>	
24	X	X	X	D	157.200	161.800	Public Correspondence (Marine Operator)	
25	X	X	X	D	157.250	161.850	Public Correspondence (Marine Operator)	
26	X	X	X	D	157.300	161.900	Public Correspondence (Marine Operator)	
27	X	X	X	D	157.350	161.950	Public Correspondence (Marine Operator)	
28	X	X	X	D	157.400	162.000	Public Correspondence (Marine Operator)	

VHF MARINE CHANNEL CHART							
CH	U	C	I	S/D	TX	RX	CHANNEL USE
60		X	X	D	156.025	160.625	Public Correspondence (Marine Operator)
61			X	D	156.075	160.675	Public Correspondence (Marine Operator), Port operation, ship movement
61A		X		S	156.075		Public Coast: Coast Guard; East Coast: commercial fishing only
62			X	D	156.125	160.725	Public Correspondence (Marine Operator), Port operation, ship movement
62A		X		S	156.125		Public Coast: Coast Guard; East Coast: commercial fishing only
63			X	D	156.175	160.775	Public Correspondence (Marine Operator), Port operation, ship movement
63A	X	X		S	156.175		Port Operation and Commercial. VTS in selected areas.
64		X	X	D	156.225	160.825	Public Correspondence (Marine Operator), Port operation, ship movement
64A		X		S	156.225		Public Correspondence (Marine Operator), Port operation, ship movement
65			X	D	156.275	160.875	Public Correspondence (Marine Operator), Port operation, ship movement
65A	X	X		S	156.275		Port Operations
66			X	D	156.325	160.925	Public Correspondence (Marine Operator), Port operation, ship movement
66A	X	X		S	156.325		Port Operations
67	X	X	X	S	156.375		US: Commercial. Used for Bridge-to-bridge com muni-cations in lower Mississippi River. Inter-ship only, Canada: Commercial fishing, S&R
68	X	X	X	S	156.425		Non-commercial (Recreational)
69	X	X	X	S	156.475		US: Non-commercial (Recreational), Canada: Commercial fishing only, International: Inter-ship, Port operations and Ship movement
70	X	X	X	S	156.525		Digital selective calling (voice communications not allowed)
71	X	X	X	S	156.575		US, Canada: Non-commercial (Recreational), International: Port operations and Ship movement
72	X	X	X	S	156.625		Non-commercial (Inter-ship only)
73	X	X	X	S	156.675		US: Port Operations, Canada: Commercial fish ing only, International: Inter-ship, Port operations and Ship movement
74	X	X	X	S	156.725		US: Port Operations, Canada: Commercial fishing only, International: Inter-ship, Port operations and Ship movement
75	X	X	X	S	156.775		Port Operations (Inter-ship only) (1W)
76	X	X	X	S	156.825		Port Operations (Inter-ship only) (1W)
77	X	X		S	156.875		Port Operations (Inter-ship only) (1W)
77			X	S	156.875		Port Operations (Inter-ship only)
78			X	D	156.925	161.525	Public Correspondence (Marine Operator), Port operation, ship-movement
78A	X	X		S	156.925		Non-commercial (Recreational)
79			X	D	156.975	161.575	Port operation and Ship movement
79A	X	X		S	156.975		Commercial

VHF MARINE CHANNEL CHART							
CH	U	C	I	S/D	TX	RX	CHANNEL USE
80			X	D	157.025	161.625	Port operation, ship movement
80A	X	X		S	157.025		Commercial
81			X	D	157.075	161.675	Port operation, ship movement
<b>81A</b>	<b>X</b>			<b>S</b>	<b>157.075</b>		<b>U.S. Government Only - Environmental protection operations.</b>
81A		X		S	157.075		Canadian Coast Guard Only
82			X	D	157.125	161.725	Public Correspondence (Marine Operator), Port operation, ship movement
<b>82A</b>	<b>X</b>	<b>X</b>		<b>S</b>	<b>157.125</b>		<b>U.S. Government Only, Canadian Coast Guard Only</b>
83		X		D	157.175	161.775	Canadian Coast Guard Only
83			X	D	157.175	161.775	Public Correspondence (Marine Operator)
<b>83A</b>	<b>X</b>	<b>X</b>		<b>S</b>	<b>157.175</b>		<b>U.S. Government Only, Canadian Coast Guard Only</b>
84	X	X	X	D	157.225	161.825	Public Correspondence (Marine Operator)
85	X	X	X	D	157.275	161.875	Public Correspondence (Marine Operator)
86	X	X	X	D	157.325	161.925	Public Correspondence (Marine Operator)
87		X	X	S	157.375		Port operation, ship movement
87A	X			S	157.375		Public Correspondence (Marine Operator)
88		X	X	S	157.425		Port operation, ship movement
88A	X			S	157.425		Commercial, Inter-ship Only
WX01	X	X	X	D	---	162.550	Weather (receive only)
WX02	X	X	X	D	---	162.400	Weather (receive only)
WX03	X	X	X	D	---	162.475	Weather (receive only)
WX04	X	X	X	D	---	162.425	Weather (receive only)
WX05	X	X	X	D	---	162.450	Weather (receive only)
WX06	X	X	X	D	---	162.500	Weather (receive only)
WX07	X	X	X	D	---	162.525	Weather (receive only)
WX08	X	X	X	D	---	161.650	Weather (receive only)
WX09	X	X	X	D	---	161.775	Weather (receive only)
WX10	X	X	X	D	---	163.275	Weather (receive only)

The above **BOLD** channels are not for use of the general public in U.S. waters, unless proper authorization is given.

Channel designator	Carrier frequency (MHz)		Points of communication (Intership and between coast and ship unless otherwise indicated)	
	Ship transmit	Coast transmit		
<b>Port Operations</b>				
01A <sup>1</sup>	156.050	156.050	Intership only.	
63A <sup>1</sup>	156.175	156.175		
05 <sup>2</sup>	156.250	156.250		
65A	156.275	156.275		
66A	156.325	156.325		
12 <sup>3</sup>	156.600	156.600		
73	156.675	156.675		
14 <sup>3</sup>	156.700	156.700		
74	156.725	156.725		
77 <sup>4</sup>	156.875			
20	157.000	161.600		
20A <sup>12</sup>	157.000			
<b>Navigational (Bridge-to-Bridge)<sup>5</sup></b>				
13 <sup>6</sup>	156.650	156.650		
67 <sup>7</sup>	156.375	156.375		
<b>Commercial</b>				
01A <sup>1</sup>	156.050	156.050	Intership only. Do.	
63A <sup>1</sup>	156.175	156.175		
07A	156.350	156.350		
67 <sup>7</sup>	156.375			
08	156.400	.....		
09	156.450	156.450		
10	156.500	156.500		
11 <sup>3</sup>	156.550	156.550		
18A	156.900	156.900		
19A	156.950	156.950		
79A	156.975	156.975		
80A	157.025	157.025		
88A <sup>8</sup>	157.425	.....		
72 <sup>14</sup>	156.625	.....		
<b>Digital Selective Calling</b>				
70 <sup>15</sup>	156.525	156.525		

Channel designator	Carrier frequency (MHz)		Points of communication (Intership and between coast and ship unless otherwise indicated)
	Ship transmit	Coast transmit	
<b>Noncommercial</b>			
68 <sup>17</sup>	156.425	156.425	Intership only. Great Lakes only. Do. Internship only.
09 <sup>16</sup>	156.450	156.450	
69	156.475	156.475	
71	156.575	156.575	
72	156.625	.....	
78A	156.925	156.925	
79A	156.975	156.975	
80A	157.025	157.025	
67 <sup>14</sup>	156.375	.....	
<b>Distress, Safety and Calling</b>			
16	156.800	156.800	EPRIB
<b>Intership Safety</b>			
06	156.300	.....	a. Intership, or b. For SAR: Ship and aircraft for the U.S. Coast Guard.
<b>Environmental</b>			
15 <sup>13</sup>	.....	156.750	Coast to ship only.
<b>Maritime Control</b>			
17 <sup>9,10</sup>	156.850	156.850	
<b>Liaison, U.S. Coast Guard</b>			
22A <sup>11</sup>	157.100	157.100	Ship, aircraft, and coast stations of the U.S. Coast Guard and at Lake Mead, Nev., ship and coast stations of the National Park Service, U.S. Department of the Interior.

- 156.050 MHz and 156.175 MHz are available for port operations and commercial communications purposes when used only within the U.S. Coast Guard designated Vessel Traffic Services (VTS) area of New Orleans, on the lower Mississippi River from the various pass entrances in the Gulf of Mexico to Devil's Swamp Light at River Mile 242.4 above head of passes near Baton Rouge.
- 156.250 MHz is available for port operations communications use only within the U.S. Coast Guard designated VTS radio protection areas of New Orleans and Houston described in Sec. 80.383. 156.250 MHz is available for intership port operations communications used only within the area of Los Angeles and Long Beach harbors, within a 25-nautical mile radius of Point Fermin, California.
- 156.550 MHz, 156.600 MHz and 156.700 MHz are available in the U.S. Coast Guard designated port areas only for VTS communications and in the Great Lakes available primarily for communications relating to the movement of ships in sectors designated by the St. Lawrence Seaway Development Corporation or the U.S. Coast Guard. The use of these frequencies outside VTS and ship movement sector protected areas is permitted provided they cause no interference to VTS and ship movement communications in their respective designated sectors.

- 4: Use of 156.875 MHz is limited to communications with pilots regarding the movement and docking of ships. Normal output power must not exceed 1 watt.
- 5: 156.375 MHz and 156.650 MHz are available primarily for intership navigational communications. These frequencies are available between coast and ship on a secondary basis when used on or in the vicinity of locks or drawbridges. Normal output power must not exceed 1 watt. Maximum output power must not exceed 10 watts for coast stations or 25 watts for ship stations.
- 6: On the Great Lakes, in addition to bridge-to-bridge communications, 156.650 MHz is available for vessel control purposes in established vessel traffic systems. 156.650 MHz is not available for use in the Mississippi River from South Pass Lighted Whistle Buoy "2" and Southwest Pass entrance Midchannel Lighted Whistle Buoy to mile 242.4 above Head of Passes near Baton Rouge. Additionally it is not available for use in the Mississippi River-Gulf Outlet, the Mississippi River-Gulf Outlet Canal, and the Inner Harbor Navigational Canal, except to aid the transition from these areas.
- 7: Use of 156.375 MHz is available for navigational communications only in the Mississippi River from South Pass Lighted Whistle Buoy "2" and Southwest Pass entrance Midchannel Lighted Whistle Buoy to mile 242.4 above head of Passes near Baton Rouge, and in addition over the full length of the Mississippi River-Gulf Outlet Canal from entrance to its junction with the Inner Harbor Navigation Canal, and over the full length of the Inner Harbor Navigation Canal from its junction with the Mississippi River to its entry to Lake Pontchartrain at the New Seabrook vehicular bridge.
- 8: Within 120 km (75 miles) of the United States/Canada border, in the area of the Puget Sound and the Strait of Juan de Fuca and its approaches, 157.425 MHz is half of the duplex pair designated as Channel 88. In this area, Channel 88 is available to ship stations for communications with public coast stations only. More than 120 km (75 miles) from the United States/Canada border in the area of the Puget Sound and the Strait of Juan de Fuca, its approaches, the Great Lakes, and the St. Lawrence Seaway, 157.425 MHz is available for intership and commercial communications. Outside Puget Sound area and its approaches and the Great Lakes, 157.425 MHz is also available for communications between commercial fishing vessels and associated aircraft while engaged in commercial fishing activities.
- 9: When the frequency 156.850 MHz is authorized, it may be used additionally for search and rescue training exercises conducted by state or local governments.
- 10: The frequency 156.850 MHz is additionally available to coast stations on the Great Lakes for transmission of scheduled Coded Marine Weather Forecasts (MAFOR), Great Lakes Weather Broadcast (LAWEB) and nscheduled Notices to Mariners or Bulletins. F3C and J3C emissions are permitted. Coast Stations on the Great Lakes must cease weather broadcasts which cause interference to stations operating on 156.800 MHz until the interference problem is resolved.
- 11: The frequency 157.100 MHz is authorized for search and rescue training exercises by state or local government in conjunction with U.S. Coast Guard stations. Prior U.S. Coast Guard approval is required. Use must cease immediately on U.S. Coast Guard request.
- 12: The duplex pair for channel 20 (157.000/161.600 MHz) may be used for ship to coast station communications.
- 13: Available for assignment to coast stations, the use of which is in accord with an agreed program, for the broadcast of information to ship stations concerning the environmental conditions in which vessels operate, i.e., weather; sea conditions; time signals; notices to mariners; and hazards to navigation.
- 14: Available only in the Puget Sound and the Strait of Juan de Fuca.
- 15: The frequency 156.525 MHz is to be used exclusively for distress, safety and calling using digital selective calling techniques. No other uses are permitted.
- 16: The frequency 156.450 MHz is available for intership, ship and coast general purpose calling by noncommercial vessels, such as recreational boats and private coast stations.
- 17: The frequency 156.425 MHz is assigned by rule to private coast stations in Alaska for facsimile transmissions as well as voice communications.



## 17 WARRANTY

### Marine Products Limited Warranty

STANDARD HORIZON (a division of Vertex Standard) warrants, to the original purchaser only, each new Marine Communications Product ("Product") manufactured and/or supplied by STANDARD HORIZON against defects in materials and workmanship under normal use and service for a period of time from the date of purchase as follows:

#### **Fixed Mount and Portable Transceivers**

**1 year - if purchased before 01/01/91**

**3 years - if purchased between 01/01/91 and 01/01/94**

**3 years Waterproof - if purchased after 01/01/94**

#### **Loud hailers**

**1 year - if purchased before 01/01/91**

**3 years - if purchased after 01/01/91**

#### **Associated Chargers**

**1 year - if purchased before 01/01/91**

**3 years - if purchased after 01/01/91**

**Associated Batteries** - 1 year. Note: Batteries will be deemed defective only if storage capacity drops below 80% of rated capacity or if leakage develops.

**Associated Accessories** - 1 year. Includes: Microphones/Handsets, External Speakers, Antennas, Carrying Accessories, Power Supplies, and Signaling Boards.

To receive warranty service, the purchaser must deliver the Product, transportation and insurance prepaid, to STANDARD HORIZON (a division of Vertex Standard), Attention Marine repairs 10900 Walker Street, Cypress, CA 90630. Include proof of purchase indicating model, serial number, and date of purchase. STANDARD HORIZON will return the Product to the purchaser freight prepaid. Products purchased prior to January 1, 1991 will bear the STANDARD HORIZON warranty terms in effect prior to that date.

In the event of a defect, malfunction or failure of the Product during the warranty period, STANDARD HORIZON's liability for any breach of contract or any breach of express or implied warranties in connection with the sale of Products shall be limited solely to repair or replacement, at its option, of the Product or part(s) therein which, upon examination by STANDARD HORIZON, appear to be defective or not up to factory specifications. STANDARD HORIZON may, at its option, repair or replace parts or subassemblies with new or reconditioned parts and subassemblies. Parts thus repaired or replaced are warranted for the balance of the original applicable warranty.



STANDARD HORIZON will not warrant installation, maintenance or service of the Products. In all instances, STANDARD HORIZON's liability for damages shall not exceed the purchase price of the defective Product.

This warranty only extends to Products sold within the 50 States of the United States of America and the District of Columbia.

STANDARD HORIZON will pay all labor to repair the product and replacement parts charges incurred in providing the warranty service except where purchaser abuse or other qualifying exceptions exist. The purchaser must pay any transportation expenses incurred in returning the Product to STANDARD HORIZON for service.

This limited warranty does not extend to any Product which has been subjected to misuse, neglect, accident, incorrect wiring by anyone other than STANDARD HORIZON, improper installation, or subjected to use in violation of instructions furnished by STANDARD HORIZON, nor does this warranty extend to Products on which the serial number has been removed, defaced, or changed. STANDARD HORIZON cannot be responsible in any way for ancillary equipment not furnished by STANDARD HORIZON which is attached to or used in connection with STANDARD HORIZON's Products, or for the operation of the Product with any ancillary equipment, and all such equipment is expressly excluded from this warranty. STANDARD HORIZON disclaims liability for range, coverage, or operation of the Product and ancillary equipment as a whole under this warranty. STANDARD HORIZON reserves the right to make changes or improvements in Products, during subsequent production, without incurring the obligation to install such changes or improvements on previously manufactured Products.

The implied warranties which the law imposes on the sale of this Product are expressly LIMITED, in duration, to the time period specified above. STANDARD HORIZON shall not be liable under any circumstances for consequential damages resulting from the use and operation of this Product, or from the breach of this LIMITED WARRANTY, any implied warranties, or any contract with STANDARD HORIZON. IN CONNECTION WITH THE SALE OF ITS PRODUCTS, STANDARD HORIZON MAKES NO WARRANTIES, EXPRESS OR IMPLIED AS TO THE MERCHANTABILITY OR FITNESS FOR A PARTICULAR PURPOSE OR OTHERWISE, EXCEPT AS EXPRESSLY SET FORTH HEREIN.

Some states do not allow the exclusion or limitation of incidental or consequential damages, or limitation on how long an implied warranty lasts, so the above limitations or exclusions may not apply. This warranty gives specific legal rights, and there may be other rights which may vary from state to state.

ONLY PRODUCTS SOLD ON OR AFTER JANUARY 1, 1991 ARE COVERED UNDER THE TERMS OF THIS LIMITED WARRANTY.

## ON-LINE WARRANTY REGISTRATION

THANK YOU for buying Marine Division of Vertex Standard products! We are confident your new radio will serve your needs for many years!

Please visit **[www.standardhorizon.com](http://www.standardhorizon.com)** to register the **GX1500S** Marine VHF. It should be noted that visiting the Web site from time to time may be beneficial to you, as new products are released they will appear on the STANDARD HORIZON Web site. Also a statement regarding product support should be added to the manual.

### Product Support Inquiries

If you have any questions or comments regarding the use of the **GX1500S**, you can visit the STANDARD HORIZON Web site to send an E-Mail or contact the Product Support team at (714) 827-7600 ext 6300 M-F 7:00-5:00PST.

In addition to the warranty, STANDARD HORIZON includes a lifetime "flat rate" and "customer loyalty" programs to provide service after the warranty period has expired. If you wish to obtain the flat rate price for out-of-warranty repair, you must include the information on the Owner's Record with the unit when you return it to your Dealer or to STANDARD HORIZON.

Lifetime Flat Rate Service Program: For the original Owner only, for the lifetime of the unit, STANDARD HORIZON will repair the unit to original specifications.

Note: The flat rate amount is payable by the Owner only if STANDARD HORIZON or the STANDARD HORIZON Dealer determines that a repair is needed. After the repair, a 90-day warranty will be in effect from the date of return of the unit to the Owner.

This service program is not available for equipment which has failed as a result of neglect, accident, breakage, misuse, improper installation or modification, or water damage (depending on the product).

## 18 SPECIFICATIONS

Performance specifications are nominal, unless otherwise indicated, and are subject to change without notice.

### 18.1 GENERAL

Channels .....	All USA, International and Canadian
Input Voltage .....	13.8 VDC $\pm$ 20%
Current Drain	
Standby .....	0.4 A
Receive .....	1.5 A
Transmit .....	5.5 A (Hi); 1.5 A (Lo)
Dimensions .....	3.1" H x 7" W x 5.7" D (80 H x 180 W x 145 D mm)
Flush-Mount Dimensions .....	2.5" H x 6.3" W x 5.1" D (64 H x 160 W x 130 D mm)
Weight .....	2.2 lbs (1 kg)

### 18.2 TRANSMITTER

Frequency Range .....	156.025 to 157.425 MHz
RF Output .....	25 W (Hi); 1 W (Lo)
Conducted Spurious Emissions .....	80 dB (Hi); 60 dB (Lo)
Audio Response .....	within +1/-3 of a 6 dB/octave pre-emphasis characteristic at 300 to 3000 Hz
Audio Distortion .....	5 %
Modulation .....	16K0G3E, for DSC 16K0G2B
Frequency Stability (-20°C to +50°C) .....	$\pm$ 0.0005%
FM Hum and Noise .....	50 dB

### 18.3 RECEIVER

Frequency Range .....	156.050 to 163.275 MHz
Sensitivity	
12 dB SINAD .....	0.25 $\mu$ V
12 dB SINAD (70 CH Receiver) .....	0.3 $\mu$ V
Squelch Sensitivity (Threshold) .....	0.2 $\mu$ V
Modulation Acceptance Bandwidth .....	$\pm$ 7.5 kHz
Selectivity	
Spurious and Image Rejection (TYP.) .....	-80 dB
Intermodulation and Rejection at 12 dB SINAD (TYP.) .....	-75 dB
Audio Output .....	4.5 W
Audio Response .....	within +2/-8 of a 6 dB/octave de-emphasis characteristic at 300 to 3000 Hz
Frequency Stability (-20°C to +50°C) .....	$\pm$ 0.0005 %
Channel Spacing .....	25 kHz
DSC Format .....	ITU Class D
NMEA Input/Output .....	Output - DSC, DSE Input - GLL, GGA, RMC and GNS



**STANDARD HORIZON**

**Marine Division of VERTEX STANDARD  
US Headquarters**

10900 Walker Street, Cypress, CA 90630, U.S.A.

**[www.standardhorizon.com](http://www.standardhorizon.com)**



**E M O 1 7 N 1 0 2**

Copyright 2008  
VERTEX STANDARD CO., LTD.  
All rights reserved.

No portion of this manual  
may be reproduced  
without the permission of  
VERTEX STANDARD CO., LTD.